



Wonderland

WonderLAND

MADE IN ITALY

design Giuseppe Viganò

studioViganò





WonderLand

La nuova collezione di Signorini&Coco, creata dal designer Giuseppe Viganò, nasce cogliendo ispirazione dal mondo dell'arte nelle sue molteplici sfumature: Wonderland viene alla luce grazie a concetti pittorici e materiali artigianali e innovativi.

Una collezione vivace in cui si uniscono atmosfere naturali, sogni e culture diverse, con richiami all'arte italiana e al mondo della natura. Giuseppe Viganò vuole distinguersi da un mercato saturo di prodotti omologati e, per farlo, modella una nuova identità immediatamente riconoscibile per stile, carattere e impatto emotivo.

Questa identità passa anche per la ricerca e la sperimentazione di un nuovo materiale, brevettato appositamente dal gruppo Signorini&Coco, così da creare un gusto inconfondibile, che si ritrova sia negli imbottiti che nell'arredo. Pannelli artistici fatti a mano si sposano con sagome sobrie senza tempo e con elementi più estroversi, in modo da arredare case internazionali che vogliono osare, differenziandosi dai soliti stili.

Il risultato è una collezione evocativa e attenta ai dettagli, che si sviluppa nella zona living e nella zona notte, oltre ad abbracciare il mondo dell'illuminazione, creando un sistema armonico in cui ogni pezzo si integra e si combina alla totalità del progetto.

The new Signorini&Coco collection was created by the designer Giuseppe Viganò, who drew inspiration from the world of art in its many nuances. Wonderland comes to light thanks to pictorial concepts and artisanal and innovative materials.

It is a lively collection that combines natural atmospheres, aspirations, and different cultures, reminiscent of Italian art and nature. Wishing to stand out from a market saturated with homologated products, Giuseppe Viganò shaped a new identity that is immediately discernable in terms of style, character, and emotional impact.

This identity also entailed research and experimentation of a new material, specially patented by the Signorini & Coco group, so as to create an unmistakable trend evidenced in both the upholstery and furnishings. Artistic, handmade panels are combined with timeless, sober shapes and more extrovert elements to furnish intercontinental homes that want to be audacious and different from the usual styles.

The result is an evocative collection that is attentive to details. It unfolds from the living room to the bedrooms, and also embraces the lighting systems. In the creation of this harmonious system, each piece falls into place and harmonizes with the entire project.



La creazione di un nuovo materiale è uno dei punti di forza della collezione Wonderland. Si tratta di un materiale unico, in grado di plasmare un mondo fantastico e onirico e di dar vita ad un prodotto dalla forte emozionalità. I 4 pattern creati si differenziano per forma e colore, prendendo spunto da ambiti diversi, ma con la peculiarità di essere intercambiabili; si inseriscono così in tutta la collezione, per uno stile abitativo che percorre l'intera abitazione. Wonderland trae ispirazione dall'arte italiana, dall'architettura e dal mondo della natura, con i suoi colori e le sue forme. Basta uno sguardo ai pannelli artistici decorati a mano per capire la preziosità di questo nuovo materiale che cambia sfumature a seconda della luce e del punto di vista. Il tatto ne svela la vera essenza, grazie alla tridimensionalità creata attraverso l'effetto rilievo. Riflessi madreperlati e inserimenti di parti con foglia d'oro conferiscono un ulteriore tocco di eleganza. L'attenzione ai dettagli è focus importante di tutto il percorso progettuale: ogni pattern è studiato sartorialmente in modo da armonizzarlo completamente alla totalità del progetto, diventando così punto di forza evocativo per una collezione dal sapore unico.

One of the strengths of the Wonderland Collection is the new material it has created. This material is really unique and forges a fantastic, dreamlike universe that also manages to highlight the emotionality of the product. The 4 patterns differ in form and color and draw inspiration from different fields. However, they are interchangeable and can be inserted into the entire collection for a furnishing style identifiable in all the facilities of the home. The collection was inspired in all its colors and shapes, by Italian art, architecture and the world of nature. Just one glance to the artistic hand-decorated panels, suffices to make you grasp the prestige of this material which changes its hues according to the lighting and angle from which it is viewed. The touch unveils the real essence of this material thanks to its three-dimensionality and embossed effect. The mother pearl effect and insertion of gold leaf portions confer an ulterior touch of classiness. Attention to details is the project's main focus: each pattern was deeply studied to fully harmonize with the project as a whole and has become the outstanding evocative feature of a really unique collection.



| | |
|--------------------------|-----|
| <i>Eden</i> | 09 |
| <i>Daisy table</i> | 27 |
| <i>Ant</i> | 33 |
| <i>Daisy cabinet</i> | 38 |
| <i>Daisy consolle</i> | 40 |
| <i>Dhalia</i> | 42 |
| <i>Blois</i> | 45 |
| <i>Orchidea</i> | 57 |
| <i>Boomerang night</i> | 63 |
| <i>Latifolia</i> | 72 |
| <i>Boomerang living</i> | 74 |
| <i>Butterfly</i> | 82 |
| <i>Bluebell</i> | 84 |
| <i>Boomerang cabinet</i> | 87 |
| <i>Ninfa</i> | 91 |
| <i>Wave</i> | 103 |

Eden

Un ambiente accogliente e inesplorato come il giardino primordiale: Eden mantiene le promesse sussurre dal suo nome, tanto che basta uno sguardo al divano e ai due coffee tables ovali dal piano decorato che compongono questo mondo per stupirsi delle sue trame e rivestimenti fuori dal comune. Altrettanto protagoniste, le stesse proposte dalla visibilità più semplice, sempre caratterizzate da grande artigianalità. Ogni elemento può essere combinato con il resto dell'arredo Wonderland.

Like the primordial garden, Eden is a welcoming and unexplored environment. It keeps the promises its name suggests. In fact, just a glance at the sofa and the project's two oval coffee tables with decorated top would be enough to overwhelm you with their unusual textures and linings. Even the simpler-looking items attract the limelight and bear the same characteristics of great mastery and artisanship. Each element can be combined with the rest of the Wonderland furniture.















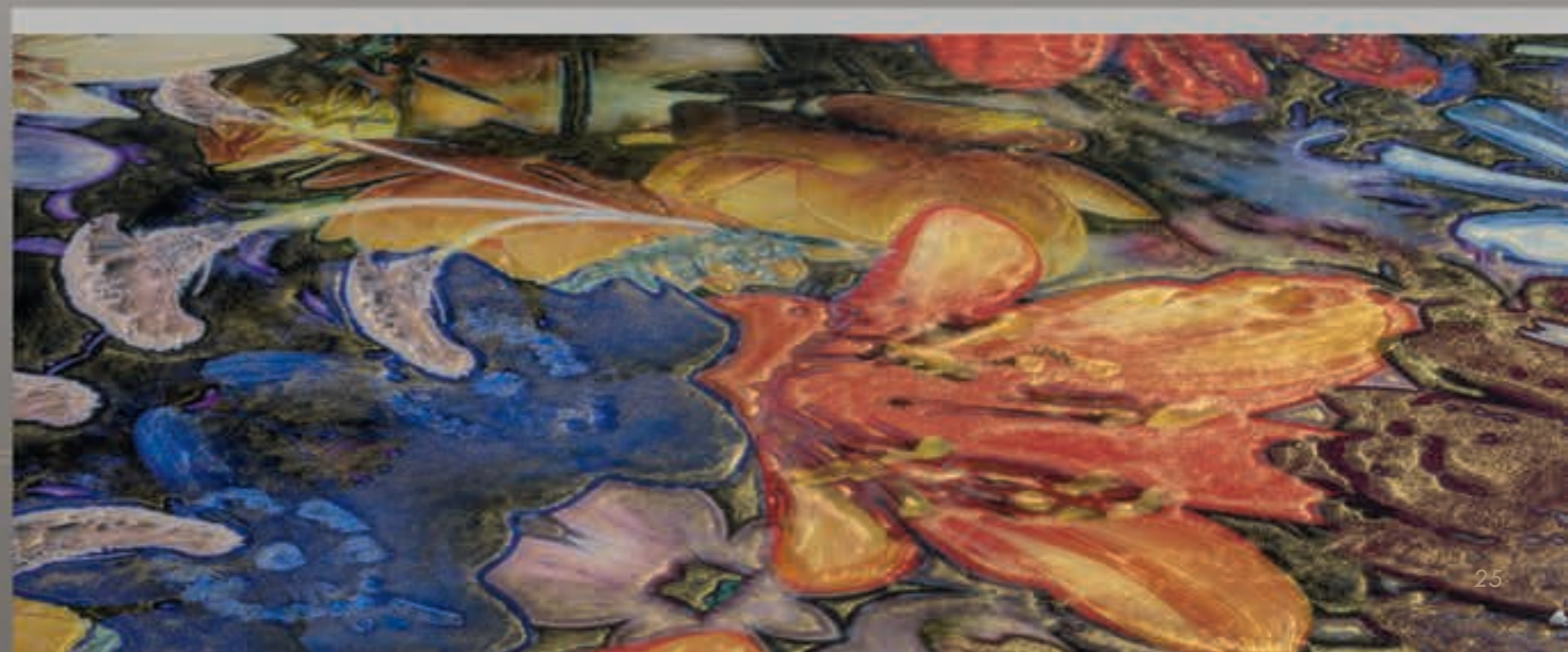

Daisy

Tema cardine di tutta la collezione, anche in Daisy la finitura artigianale è protagonista: tavolo, consolle, credenza si vestono di colori prorompenti e delle trame originali, che accompagnano le particolari forme arrotondate. Questi tre prodotti visionari arricchiranno la zona living di ispirazioni artistiche inaspettate senza cessare mai di stupire.

The key theme of the whole collection, also in the Daisy project the handcrafted finish plays the leading role. The tables, consoles, sideboards are explosions of colours and original textures that accompany the particular, rounded shapes. These three visionary products will enrich the living room and unceasingly amaze you with unexpected artistic inspirations.



Daisy table

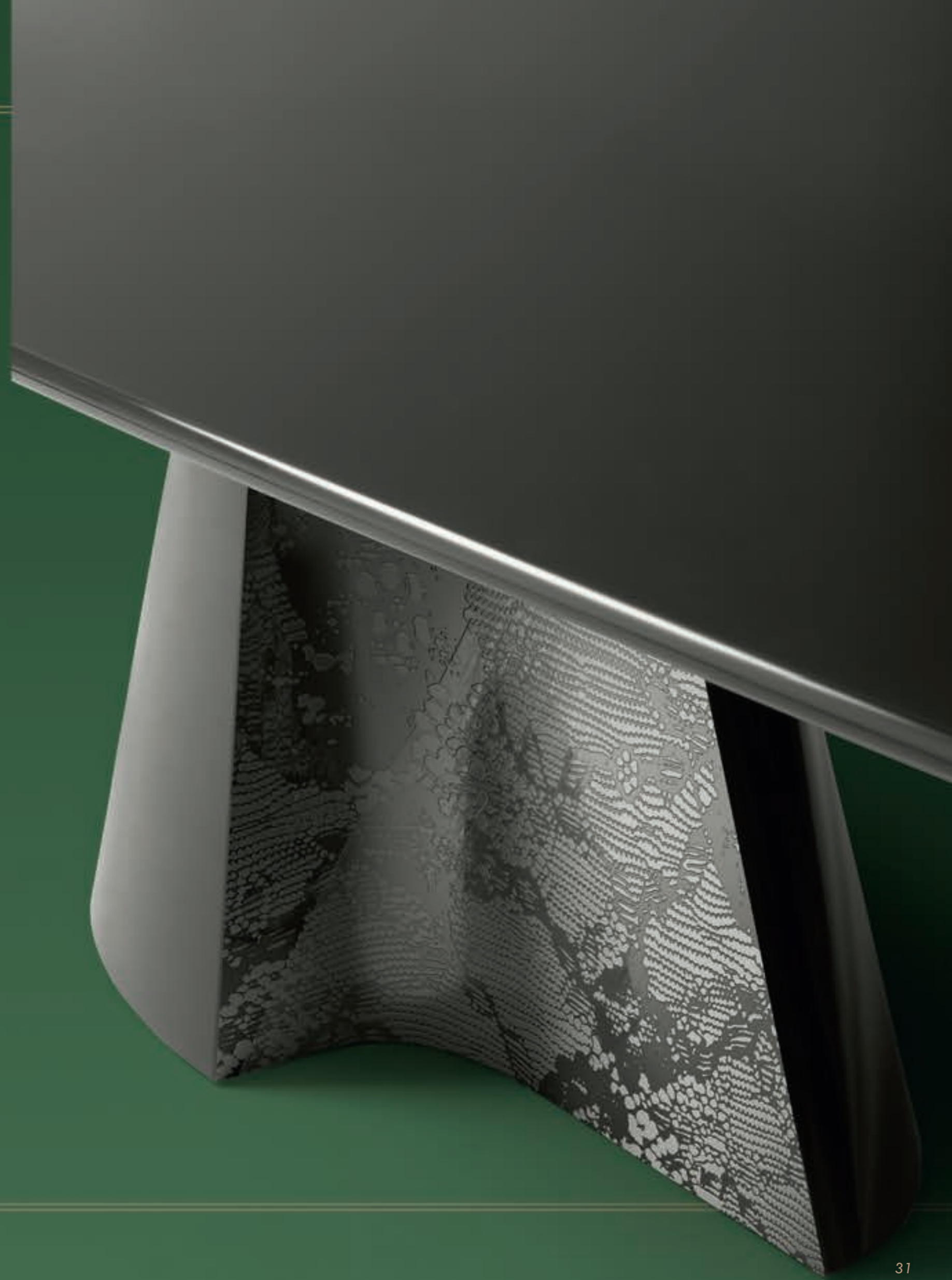
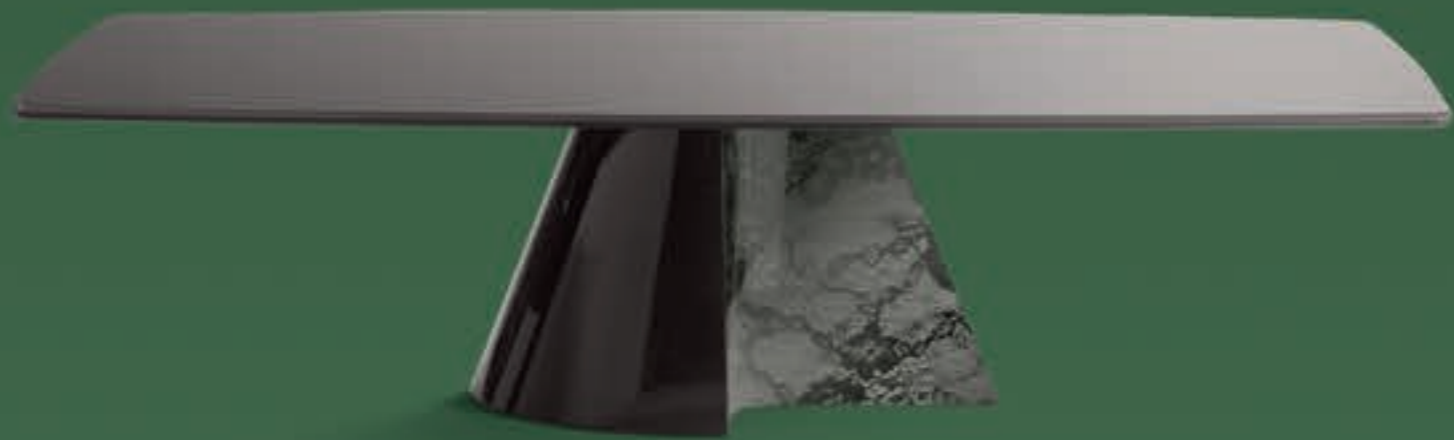





Daisy





Daisy console







Blois

Linee curve e morbide si alternano a rivestimenti colorati e fortemente caratterizzanti: Blois trova il perfetto equilibrio tra forme classiche e riferimenti contemporanei in un'armonia che non mancherà di affascinare gli amanti dello stile. Divano e tavolini possono essere personalizzati con le diverse finiture previste dalla collezione Wonderland.

The Blois project reveals curved and soft lines, alternated with colourful and highly distinctive coatings and a perfect balance between classic shapes and contemporary features. Its harmony will not fail to fascinate the lovers of style. Sofa and coffee tables can be customized with the different finishes provided by the Wonderland collection.













Orchidea

Orchidea è una poltrona affascinante, che condensa in sé tutte le ispirazioni della collezione Wonderland: arte, moda e, soprattutto, natura. La seduta, infatti, si apre come la corolla dell'omonimo fiore, comoda e confortevole. Il legame con il giardino all'italiana è sottolineato dalla base di appoggio simmetrica.

Orchidea is a captivating armchair and expresses in a nutshell, all the inspirations of the Wonderland collection: art, fashion and, above all, nature. The seat, in fact, opens out like the corolla of the namesake flower, cozy and comfortable. The symmetrical support base underlines its link with the Italian-style gardens.







Boomerang

Geometrie inaspettate e un gioco di rimandi caratterizzano il mondo Boomerang. Il nome deriva dalla particolarità dell'elemento falciforme che si ripropone sui diversi arredi che lo compongono, ovvero divano, credenza, letto, consolle, comò, comodino e pouf, creando immersivi ambienti per una zona living e una zona notte dall'identità unica.

Boomerang is a world of unexpected geometries and a game of referential links. The name derives from the particularity of the sickle-shaped element appearing in the project's furnishing compositions, i.e., sofa, sideboard, bed, console, chest of drawers, bedside table, and pouf. These items create immersive environments for living and bedroom areas with a unique identity.

















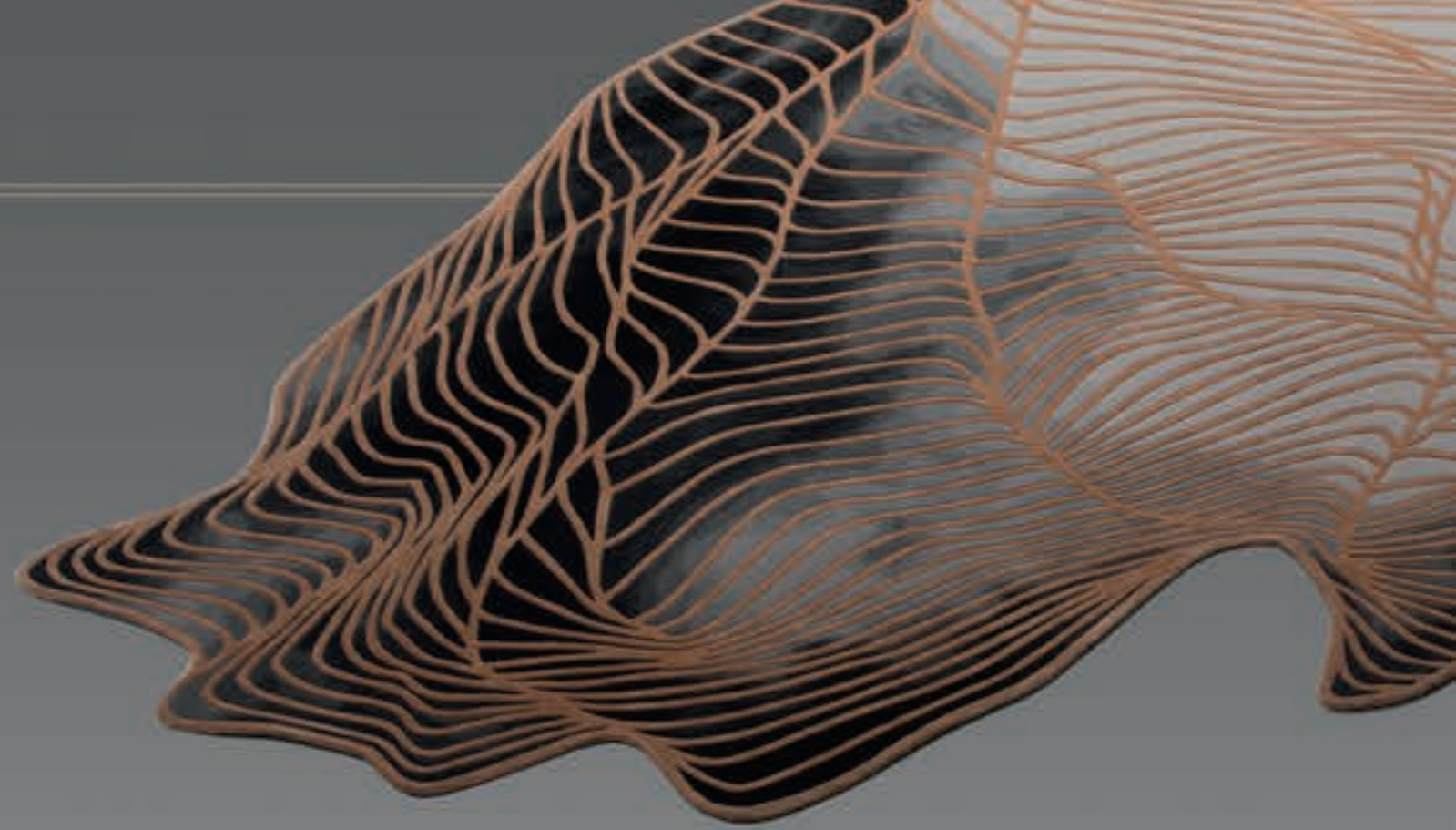

Butterfly











Ninfa

Ninfa incarna le suggestioni evocate dal nome. La testiera, imbottita e segmentata, ricorda le canne che circondano i laghi su cui poggiano le ninfee; la base, poi, sembra adagiata su correnti placide e invita a sereni riposi, come cullati dallo specchio d'acqua. E' un arredo dal forte impatto emotivo, protagonista indiscusso della camera da letto, e offre un incredibile potenziale di personalizzazione in ampiezza e colori.

Ninfa embodies the suggestions its name evokes. The padded and segmented headboard recalls the reeds surrounding the lakes where water lilies abound; the base, furthermore, seems to float on placid currents - an invitation to rest and be lulled by the water. This piece of furniture has a strong emotional impact, and certainly plays a leading role in the bedroom. It offers an incredible range of possibilities for customization in size and colours.



Ninfa





Ninfa-high







Wave

In un dialogo sommesso ma chiaramente distinguibile tra arredo e arte, Wave reinterpreta le forme classiche e le porta nel contemporaneo. Una curva dirompente plasma lo schienale del divano, e richiama alla memoria i pezzi storici delle palazzine del passato; camaleontico e dotato di infinite componibilità, questo modello dagli echi tradizionali trova il suo contrappeso nei due tavolini dal carattere squisitamente moderno che completano questo micro mondo.

In a subdued but clearly distinguishable dialogue between furniture and art, Wave reinterprets classic forms in contemporary times. A disruptive curve shapes the back of the sofa, and calls to mind the historical parts of ancient buildings. It is a chameleonic model endowed with infinite modularity, that echoes the tradition, offset by the two exquisitely modern tables that complete this micro setting.









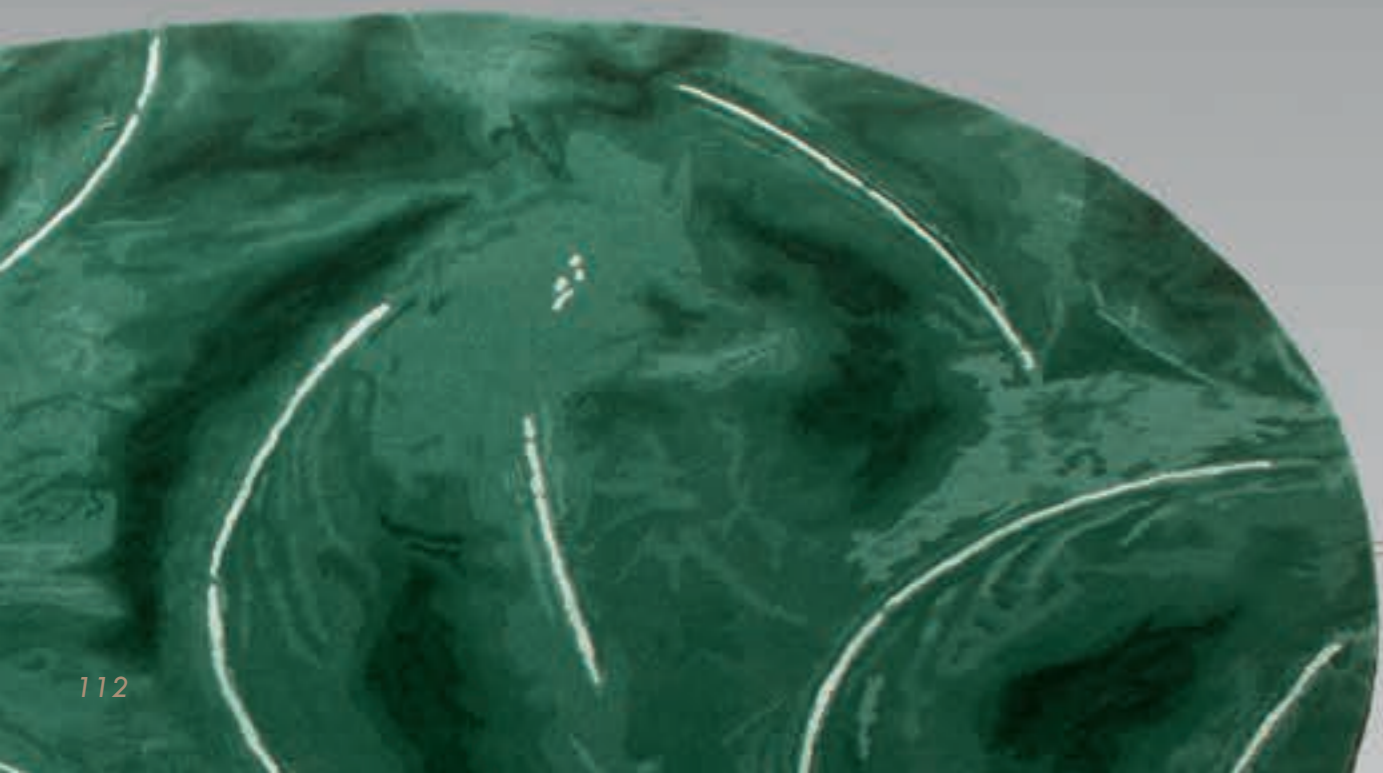
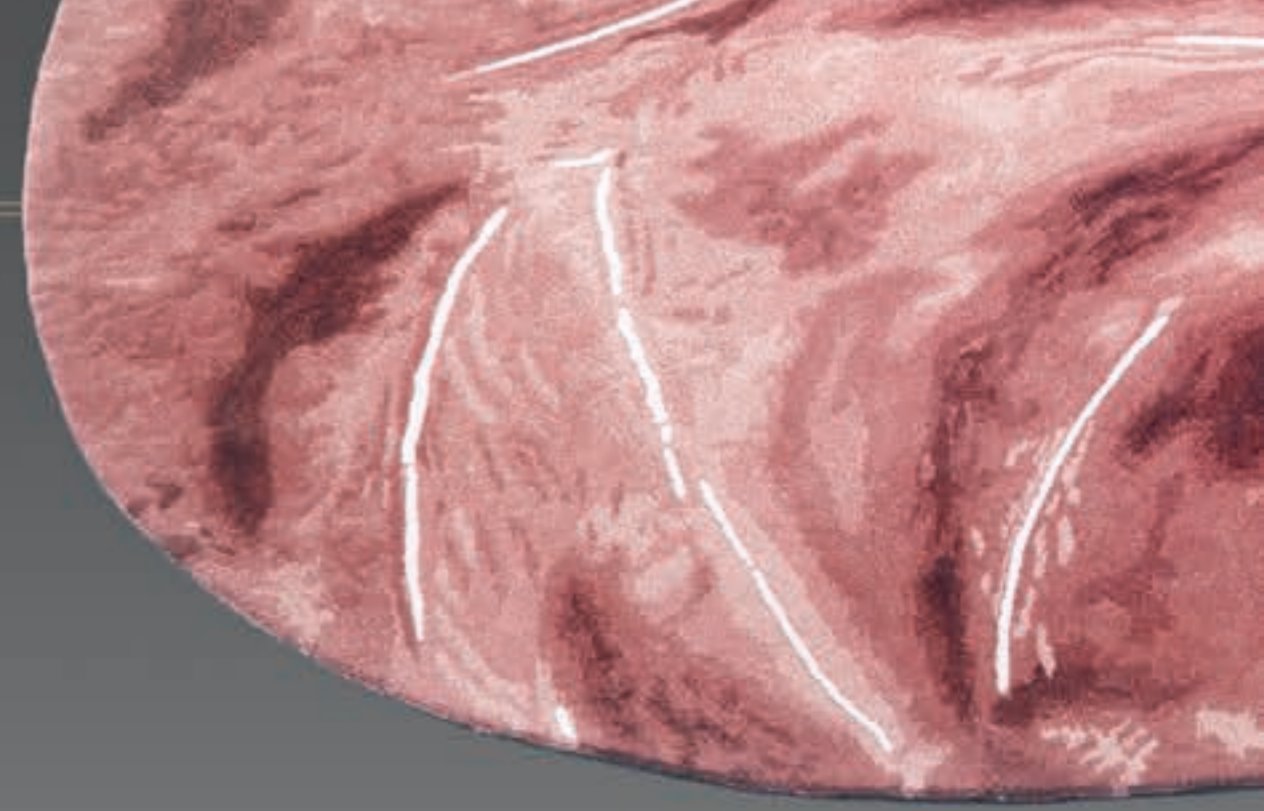





Esempi di composizione - Example of composition

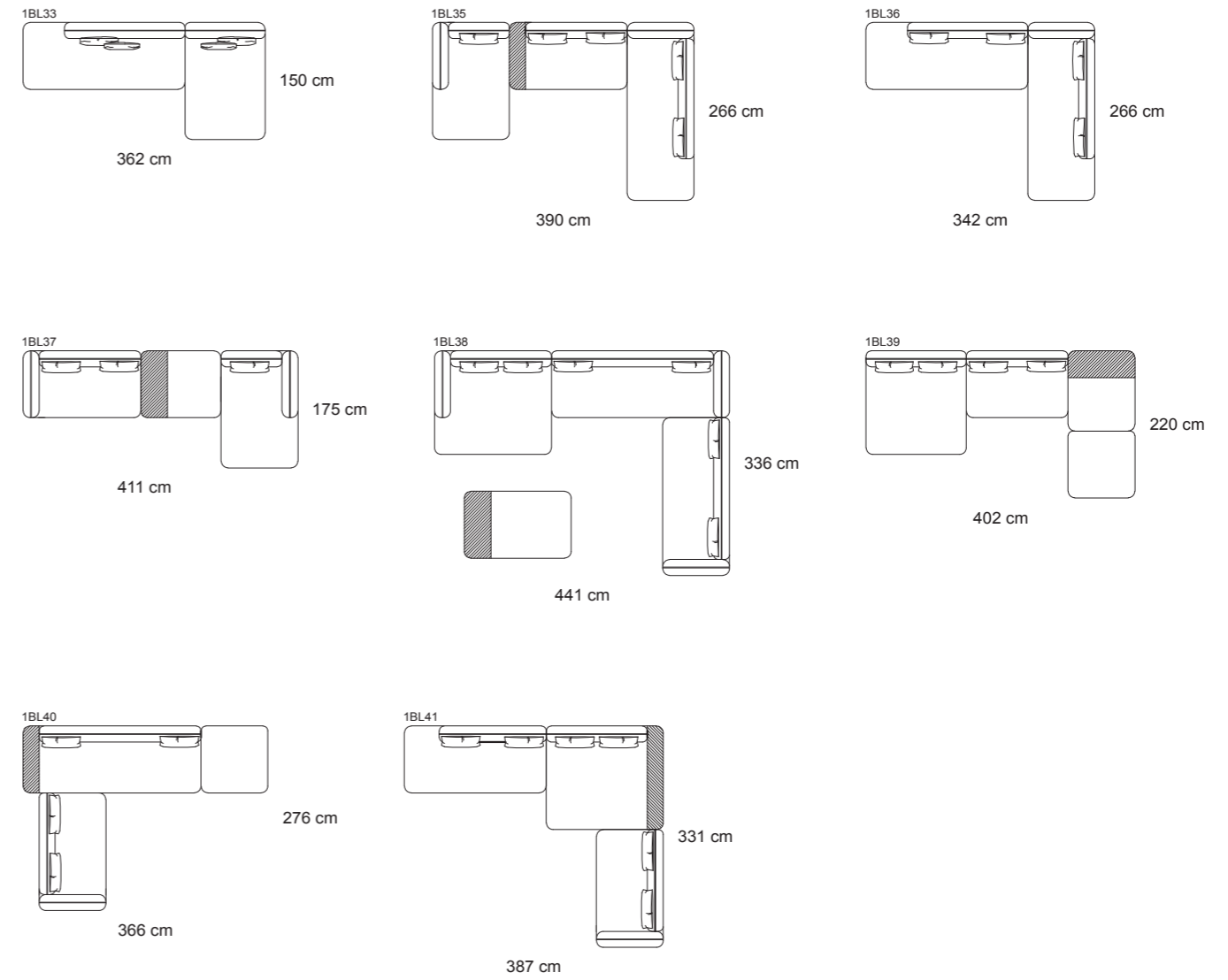

BLOIS divano

Struttura di base in multistrato di pino da 25 mm a doppio spessore rinforzata da telaio in metallo per sostegno anteriore incinghiato con nastri elastici di 6 cm. Struttura schienali e braccioli in multistrato di pino spessore 18 con interno tamponatura di compensato, sempre in pino. Assemblaggio tra struttura, braccioli e schienale tramite bulloni m8. Struttura di base ingommata con due densità: 21 nelle parti esterne, 30 nelle parti superiori per aumentare il sostegno del rivestimento. Struttura schienale imbottito con anima in densità 25 elastico rivestito con falda acrilica 350 gr. Struttura seduta in poliuretano espanso con doppia densità: 30 portante nella parte frontale e 35 prf elastico nella parte retrostante, il tutto ricoperto con lastra di memory di 3 cm rivestito in falda acrilica 350 gr. Fascia basamento in multistrato rivestita con pelle o decorata con pattern. Piedi in acciaio verniciato.

BLOIS sofa

Double-thick 25 mm multilayered poplar plywood base structure reinforced by a metal frame for front support strapped with 6 cm elastic straps. Backrest and armrests structure in poplar plywood 18 mm thick with internal plywood infills, also in poplar. Structure, armrests and backrest assembled by means of M8 bolts. Base structure rubberized with two densities: 21 in the external parts, 30 in the upper parts to increase the support of the covering. Backrest structure padded with 25LB elastic density core covered with a 350 gr acrylic layer. Seat structure in polyurethane foam (prf) with double density: 30LB density in the front part and 35LB elastic prf in the rear part, all covered with a 3 cm memory foam sheet covered in 350 gr acrylic layer. Base band in plywood covered with leather or decorated with patterns. Feet in painted steel.

Boomerang

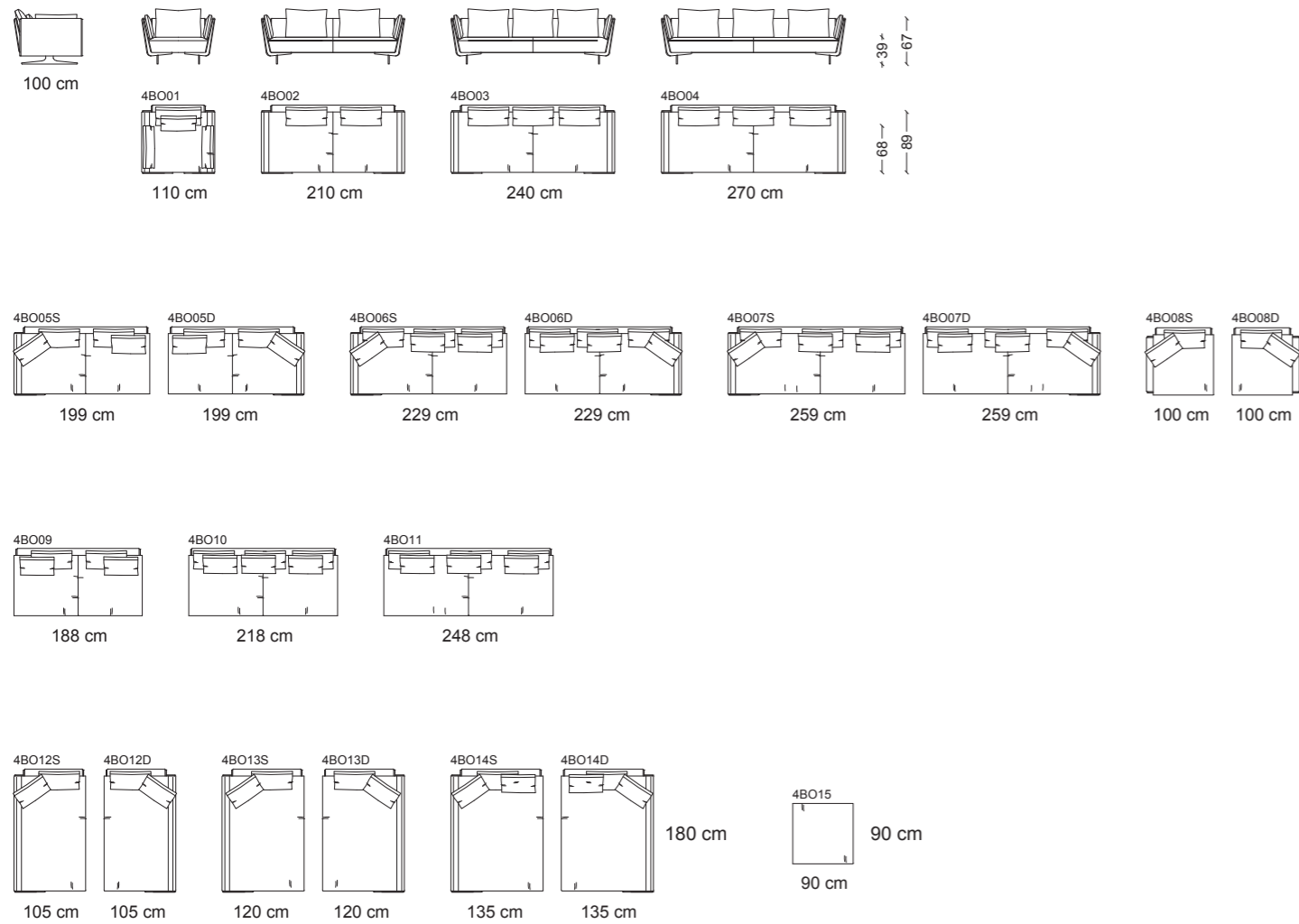

Esempi di composizione - Example of composition

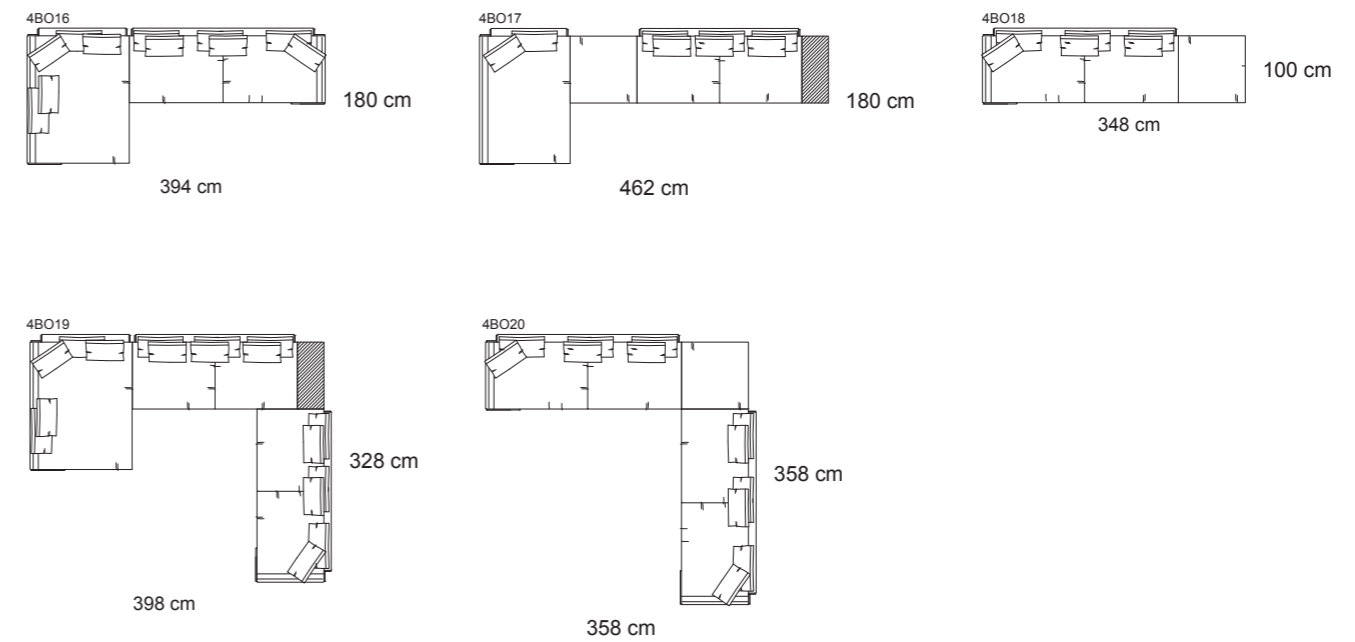

BOOMERANG divano

Struttura di base in multistrato di pino da 25 mm a doppio spessore rinforzata da profilato in metallo 50x50mm di sostegno anteriore incinghiato con nastri elastici di 6 cm.
 Struttura schienali e braccioli in multistrato di pino spessore 18 con interno tamponatura di compensato, sempre in pino.
 Assemblaggio tra struttura, braccioli e schienale tramite bulloni m8.
 Struttura di base ingommata con due densità: 21 nelle parti esterne, 70 nelle parti superiori per aumentare il sostegno del rivestimento.
 Cuscini di schienale imbottiti con anima in densità 18 incamerati in guscio di cotone antipiuma riempiti con miscela mista acrilico e piumino (fiberfil acrilico).
 Cuscini di seduta in poliuretano espanso con doppia densità: 30 portante nella parte frontale e 35 prf elastico nella parte retrostante, il tutto ricoperto con lastra di memory di 3 cm e chiuso da un guscio di cotone antipiuma con interno in piumino.
 Rivestimento cuscini completamente sfoderabile.
 Elementi laccati in multistrato con mdf.
 Basamento in acciaio verniciato a polvere ancorato alla struttura portante del telaio.

BOOMERANG sofa

Double-thick 25 mm multilayered poplar plywood base structure reinforced by a 50x50 mm front support metal sheet strapped with 6 cm elastic bands.
 Backrest and armrests structure with 18 mm thickness of multilayered poplar plywood with internal plywood infills, also in poplar.
 Structure, armrests and backrest assembled by means of M8 bolts.
 Base structure rubberized with two densities: 21LB in the external parts, 70LB in the upper parts to increase the support of the covering.
 Back cushions stuffed with 18LB density core in a feather-proof cotton shell filled with a mixed blend of acrylic and down (acrylic fiberfil).
 Seat cushions in polyurethane foam (prf) with double density: 30LB in the front part and 35LB elastic prf in the rear part, all covered with a 3-cm memory foam sheet and enclosed by a feather-proof cotton shell filled with eiderdown.
 Completely removable cushion covers.
 Lacquered elements in multilayer MDF.
 Powder-coated steel base anchored to the supporting structure of the frame.

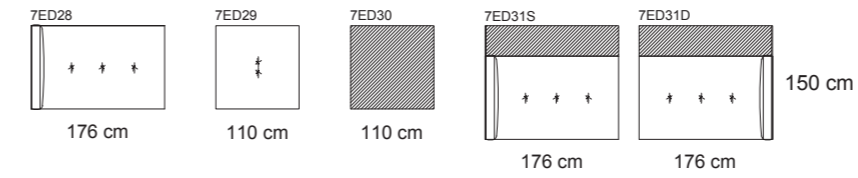
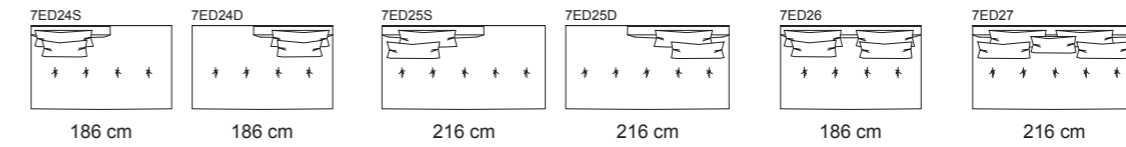
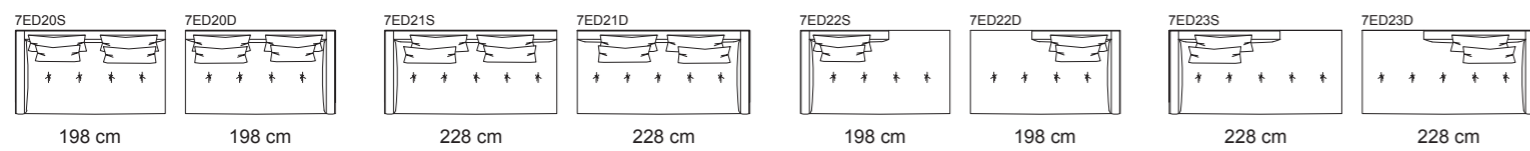
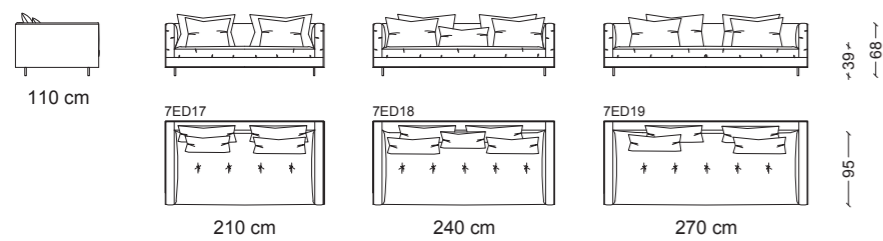
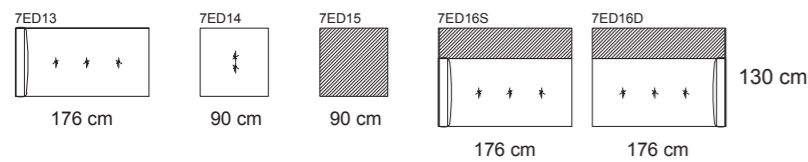
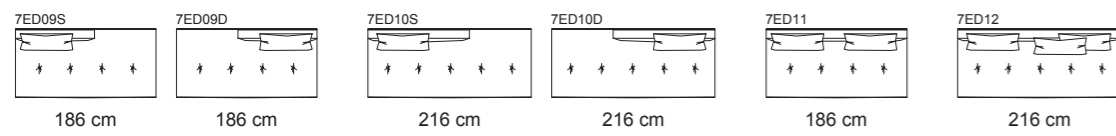
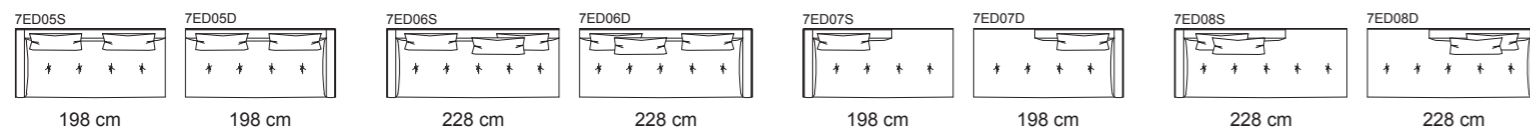
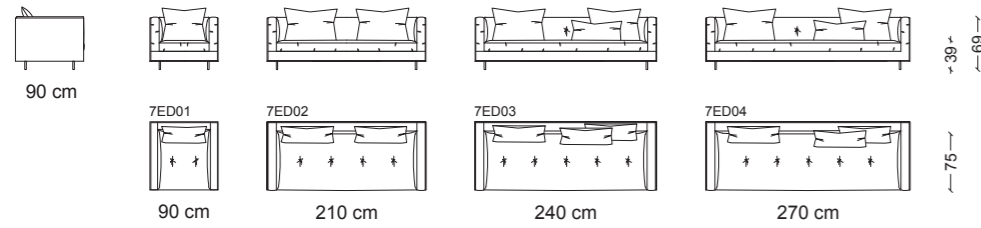

Esempi di composizione - Example of composition

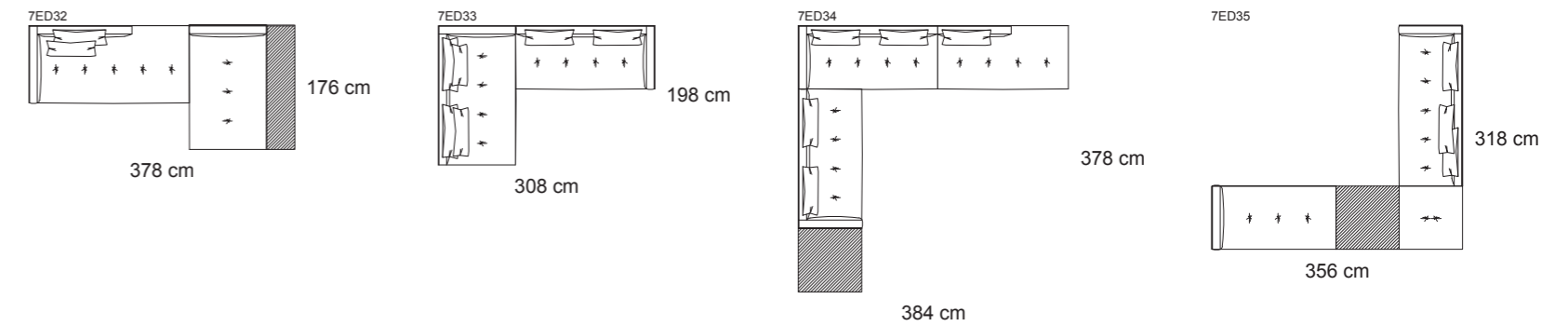

EDEN divano

Struttura di base in multistrato di pino da 25 mm a doppio spessore rinforzata da telaio in metallo per sostegno anteriore incinghiato con nastri elastici di 6 cm.
 Struttura schienali e braccioli in multistrato di pino spessore 18 con interno tamponatura di compensato sempre in pino.
 Assemblaggio tra struttura e braccioli e schienale tramite bulloni m8.
 Struttura di base ingommata con due densità: 21 nelle parti esterne, 30 nelle parti superiori per aumentare il sostegno del rivestimento.
 Struttura schienale imbottito con anima in densità 25, elastico rivestito con falda acrilica 350 gr.
 Struttura seduta in poliuretano espanso con doppia densità: 30 portante nella parte frontale e 35 prf elastico nella parte retrostante, il tutto ricoperto con lastra di memory di 3 cm rivestito in falda acrilica 350 gr.
 Pannelli esterni e fasce sotto seduta in multistrati rivestiti con pelle, tessuto, laccati o decorati con pattern.
 Piedi in acciaio verniciato.

EDEN sofa

Double-thick 25 mm multilayered poplar plywood base structure reinforced by a metal frame for front support strapped with 6 cm elastic straps.
 Backrest and armrests structure in poplar plywood thickness of 18 with internal plywood infills also in poplar.
 Structure, armrests and backrest assembled by means of M8 bolts.
 Base structure rubberized with two densities: 21LB in the external parts, 30LB in the upper parts to increase the support of the covering.
 Padded backrest structure with core density of 25LB, elastic covered with 350 gr acrylic layer.
 Seat structure in double density polyurethane foam: 30LB in the front part and 35 elastic prf in the rear, all covered with a 3-cm memory foam sheet covered in a 350 gr acrylic layer.
 Plywood seat band panels are covered with leather or decoration patterns.
 Feet in painted steel.

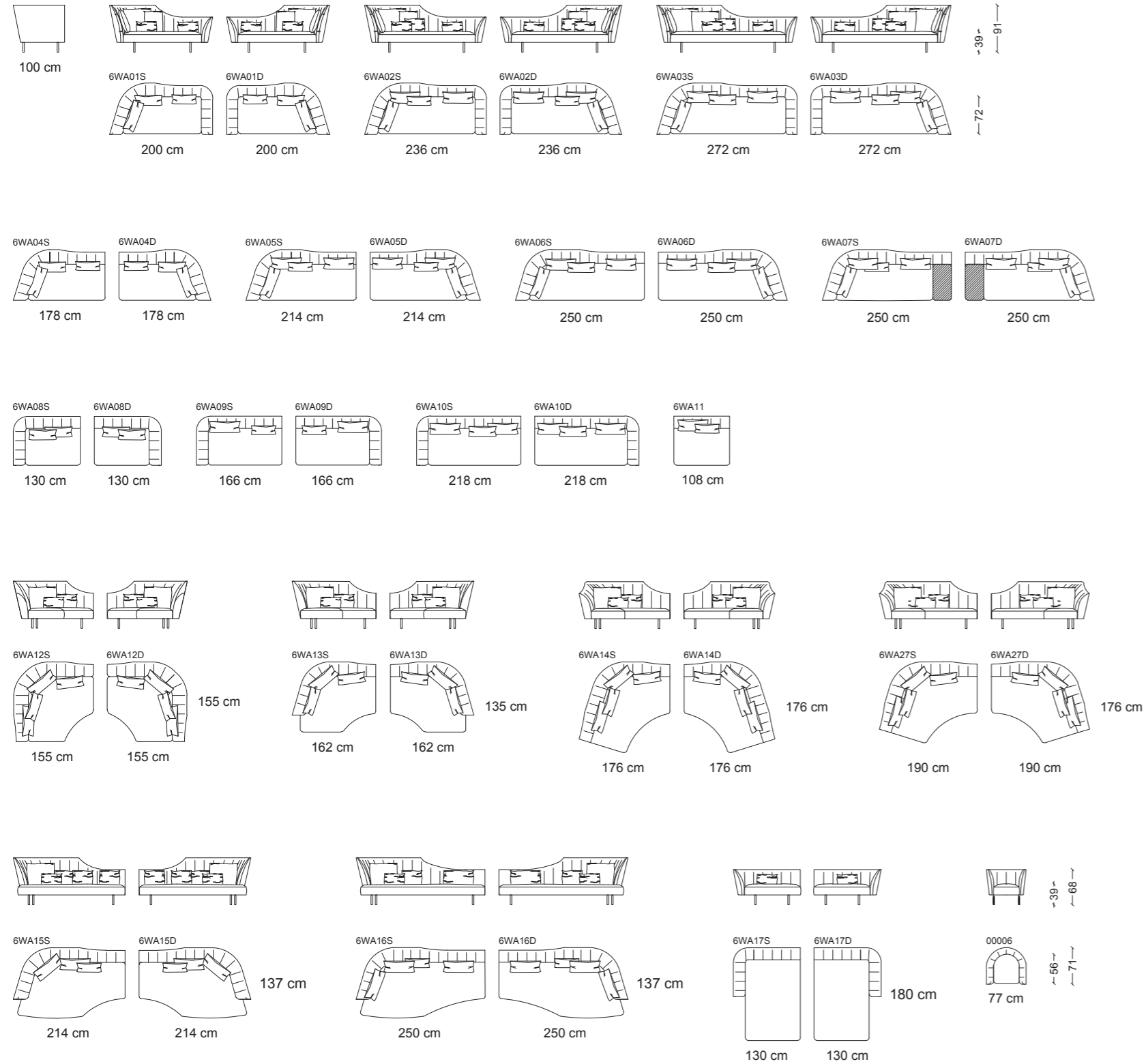

Esempi di composizione - Example of composition

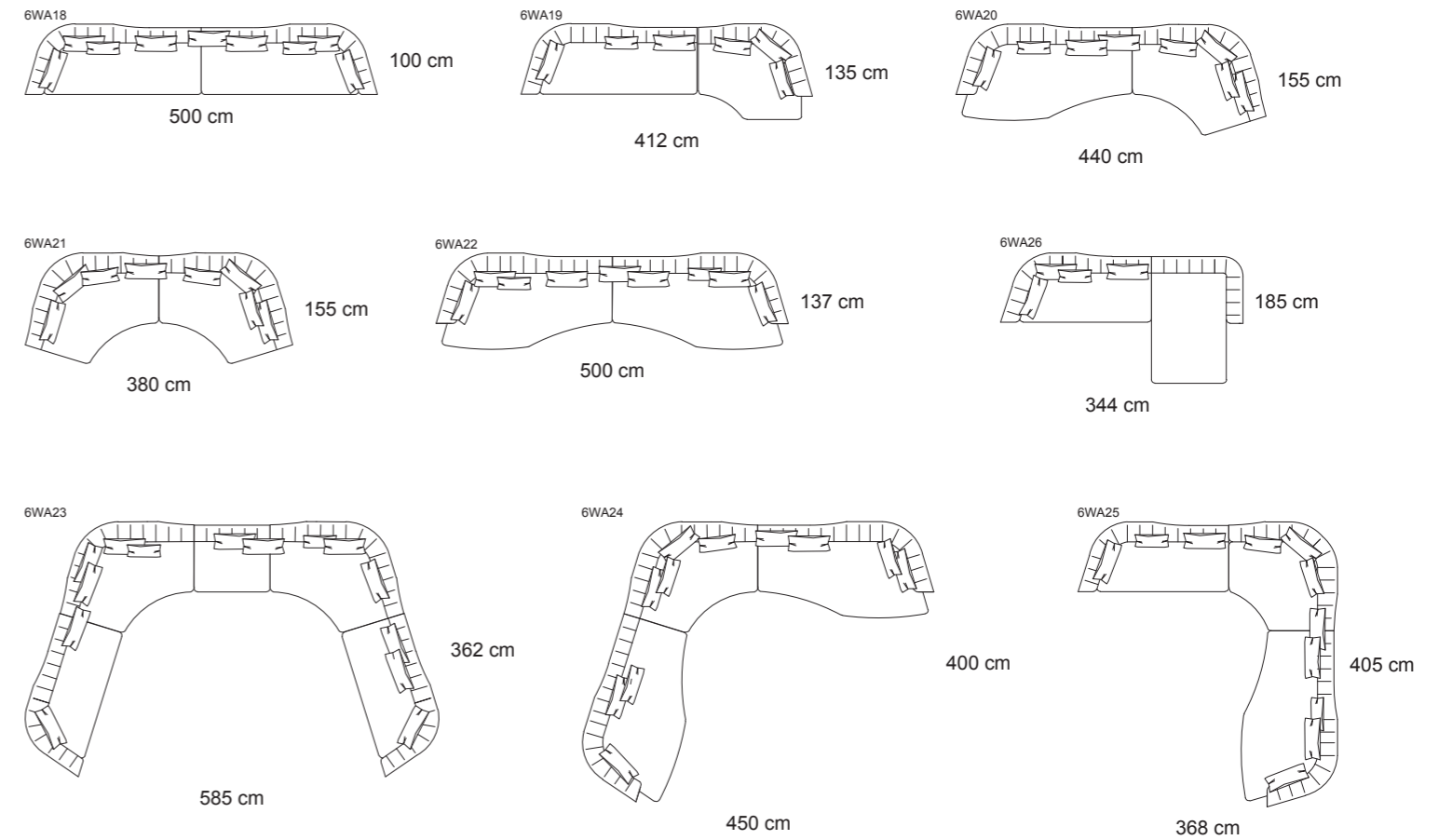

WAVE divano

Struttura di base in multistrato di pino da 25 mm a doppio spessore rinforzata da telaio in metallo per sostegno anteriore incinghiato con nastri elastici di 6 cm. Struttura schienali e braccioli in multistrato di pino spessore 18 con interno tamponatura di compensato sempre in pino. Assemblaggio tra struttura, braccioli e schienale tramite bulloni m8. Struttura di base ingommata con due densità: 21 nelle parti esterne, 30 nelle parti superiori per aumentare il sostegno del rivestimento. Struttura schienale imbottito con anima in densità 25 ed elastico rivestito con falda acrilica 350 gr. Struttura seduta in poliuretano espanso con doppia densità: 30 portante nella parte frontale e 35 prf elastico nella parte retrostante, il tutto ricoperto con lastra di memory di 3 cm rivestito in falda acrilica 350 gr. Piedi in acciaio verniciato.

WAVE sofa

Double-thick 25 mm multilayered poplar plywood base structure reinforced by a metal frame for front support strapped with 6 cm elastic straps. Backrest and armrests structure in poplar plywood thickness of 18 with internal plywood infills also in poplar. Structure, armrests and backrest all assembled by means of M8 bolts. Base structure rubberized with two densities: 21LB in the external parts, 30LB in the upper parts to increase the support of the covering. Padded backrest structure with core density of 25LB and elastic covered with 350 gr acrylic layer. Seat structure in polyurethane foam with double density: 30LB in the front part and 35 elastic prf in the rear part, all covered with a 3-cm memory foam sheet covered in 350 gr acrylic layer. Feet in painted steel.

Orchidea

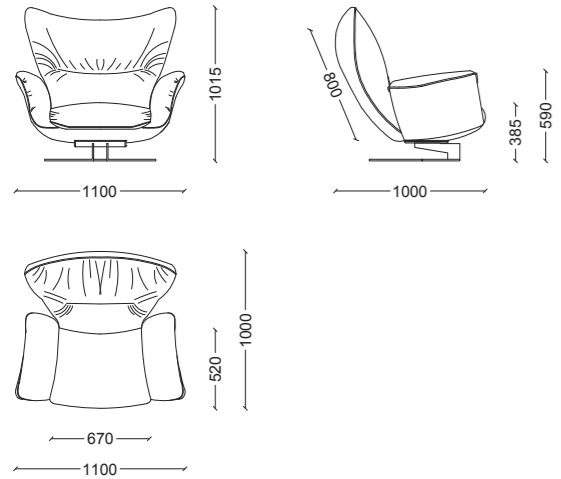

ORCHIDEA poltrona Art. 00005

L. 1100 x P. 1000 x H. 1015

Struttura di scocca in acciaio incinghiato con nastri elastici di 6 cm.
Struttura di base ingommata con due densità: 21 nelle parti esterne, 70 nelle parti superiori per aumentare il sostegno del rivestimento.
Cuscino schienale imbottito con anima in densità 18 incamerato in guscio di cotone antipiuma riempito con miscela mista acrilico e gomma Memory da 2cm.
Cuscino di seduta in poliuretano espanso con doppia densità: 30 portante nella parte frontale e 35 prf elastico nella parte retrostante, il tutto ricoperto con lastra di memory di 3 cm e chiuso da un guscio di cotone antipiuma con interno in piumino.
Basamento girevole in acciaio verniciato a polvere ancorato a struttura portante del telaio.

ORCHIDEA armchair

Body structure in steel strapped with 6-cm elastic bands.
Base structure rubberized with two densities: 21LB in the external parts, 70LB in the upper parts to increase the support of the covering.
Backrest cushion padded with core density 18LB in a feather-proof cotton shell filled with a 2cm mixed acrylic and Memory foam rubber blend.
Seat cushion in polyurethane foam with double density: 30LB in the front part and 35LB elastic prf in the rear part, all covered with a 3 cm memory foam sheet and closed by a down-proof cotton shell with an eiderdown interior.
Swivel base in powder-coated steel anchored to the supporting structure of the frame.

Blois

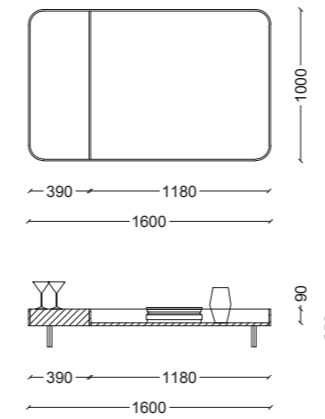

BLOIS tavolino Art. 00010

L. 1600 x P. 1000 x H. 250

Struttura in multistrati con foderina mdf per laccatura.
Piedi in acciaio verniciato. Fascia perimetrale laccata o imbottita o decorata con pattern.

BLOIS small tables

Structure in plywood with MDF lining for the lacquering.
Feet in painted steel.
Perimeter band either lacquered or padded or decorated with pattern.

Blois

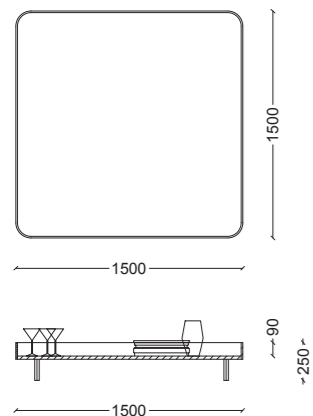

BLOIS tavolino Art. 00009

L. 1500 x P. 1500 x H. 250

Struttura in multistrati con foderina mdf per laccatura.
Piedi in acciaio verniciato. Fascia perimetrale laccata o imbottita o decorata con pattern.

BLOIS small tables

Structure in plywood with MDF lining for the lacquering.
Feet in painted steel.
Perimeter band either lacquered or padded or decorated with pattern.

Blois

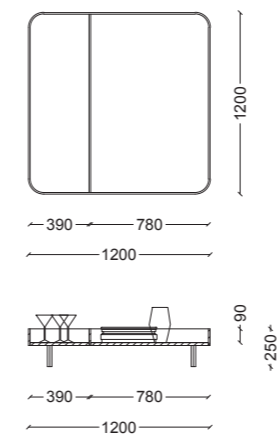

BLOIS tavolino Art. 00008

L. 1200 x P. 1200 x H. 250

Struttura in multistrati con foderina mdf per laccatura.
Piedi in acciaio verniciato. Fascia perimetrale laccata o imbottita o decorata con pattern.

BLOIS small tables

Structure in plywood with MDF lining for the lacquering.
Feet in painted steel.
Perimeter band either lacquered or padded or decorated with pattern.

Blois

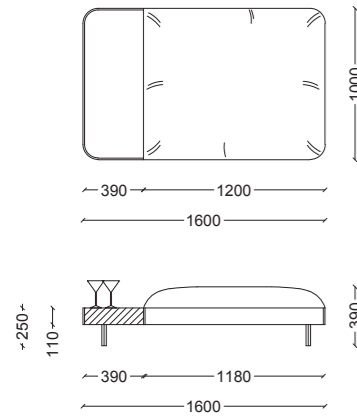

BLOIS tavolino Art. 00007

L. 1600 x P. 1000 x H. 390

Struttura in multistrati con foderina mdf per laccatura.
Piedi in acciaio verniciato. Fascia perimetrale laccata o imbottita o decorata con pattern.

BLOIS small tables

Structure in plywood with MDF lining for the lacquering.
Feet in painted steel.
Perimeter band either lacquered or padded or decorated with pattern.

Eden

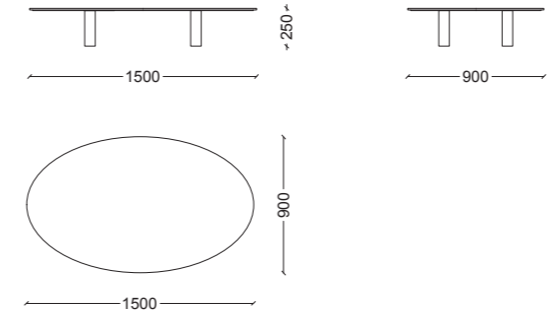

EDEN tavolino Art. 00011

L. 1500 x P. 900 x H. 250

Top in multistrati con foderina mdf.
Piedi in plexiglass extrachiaro con verniciatura sfumata a colore.
Top laccato o decorato con pattern.

EDEN small tables

Multilayer top with MDF lining.
Feet in extra-clear Plexiglas with colour gradient paint.
Top lacquered or decorated with pattern.

Blois

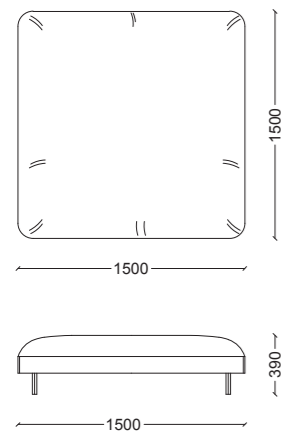

BLOIS pouff Art. 1BL18

L. 1500 x P. 1500 x H. 390

Struttura di base in multistrato di pioppo da 25 mm a doppio spessore incinghiato con nastri elastici di 6 cm.
Struttura di base ingommata con due densità ,21 nelle parti esterne ,30 nelle parti superiori per aumentare il sostegno del rivestimento.
Fascia basamento in multistrati rivestita con pelle o decorata con pattern.
Piedi in acciaio verniciato

BLOIS POUF

Multilayer base structure in polar plywood with double thickness of 25 mm strapped with 6-cm elastic bands.
Base structure rubberized with two densities: 21LB density in the external parts, 30LB in the upper parts to increase the lining's support capacity.
Multilayer base band lined with leather or decorated with patterns.
Feet in painted steel.

Eden

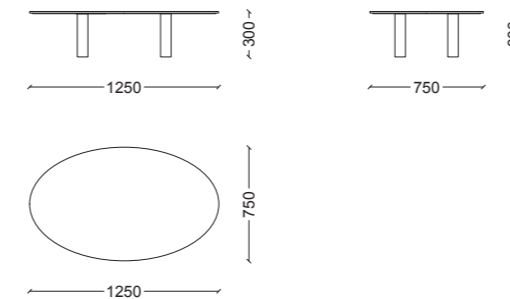

EDEN tavolino Art. 00012

L. 1250 x P. 750 x H. 300

Top in multistrati con foderina mdf.
Piedi in plexiglass extrachiaro con verniciatura sfumata a colore.
Top laccato o decorato con pattern.

EDEN small tables

Multilayer top with MDF lining.
Feet in extra-clear Plexiglas with colour gradient paint.
Top lacquered or decorated with pattern.

Wave

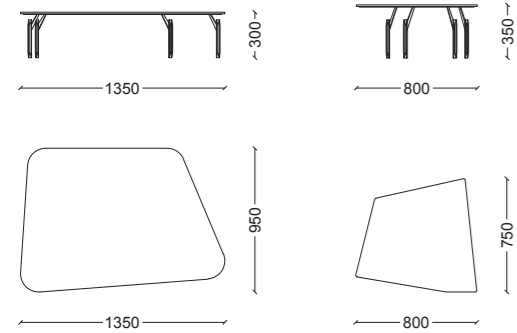

WAVE tavolino
Art. 00015

L. 1350 x P. 950 x H. 300

WAVE tavolino
Art. 00016

L. 800 x P. 750 x H. 350

Top in multistrati con foderina mdf.
Piedi in acciaio verniciati a polvere
o con vernice iridescente verde/viola.
Top laccato o decorato con pattern.

WAVE small table

Multilayer top with MDF lining.
Feet in powder-coated steel
or with green / purple iridescent paint.
Top lacquered or decorated with pattern.

Boomerang

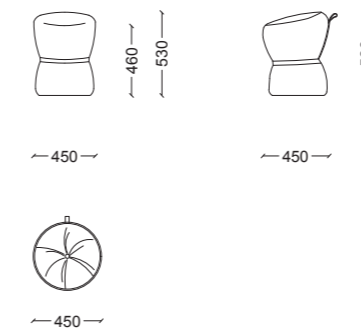

BOOMERANG pouff
Art. 00027

Ø 450 x H. 550

Struttura in multistrati curvato e sagomato,
imbottitura con gomme di varia densità,
cintura in cordoncino rilegato a mano.
Base ingommata con due densità
al fine di aumentare il sostegno del rivestimento.

BOOMERANG pouf

Structure in curved and shaped plywood,
padded with multi-density rubber,
belt in hand-bound cord.
Base rubberized with two densities
in order to increase the support of the lining.

Boomerang

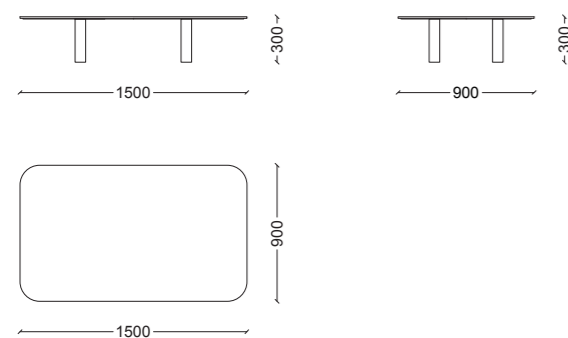

BOOMERANG tavolino
Art. 00044

L. 1500 x P. 900 x H. 300

Top in multistrati con foderina mdf.
Piedi in plexiglass extrachiaro con verniciatura sfumata a colore.
Top laccato o decorato con pattern.

BOOMERANG small tables

Multilayer top with MDF lining.
Feet in extra-clear Plexiglas with colour gradient paint.
Top lacquered or decorated with pattern.

Daisy

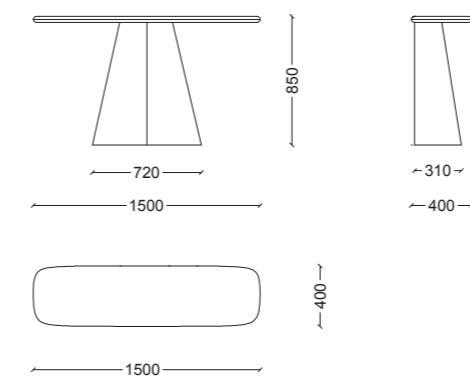

DAISY consolle
Art. 00018

L. 1500 x P. 400 x H. 850

Struttura top e sottotop in multistrati e mdf.
Laccatura glossy e decorazioni pattern su basamento e top.

DAISY console

Top and undertop structure in multilayer and MDF plywood.
Glossy lacquering and pattern decorations on base and top.

Daisy

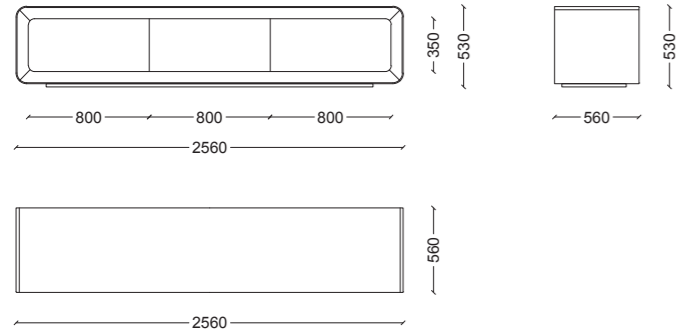

DAISY porta tv Art. 00021

L. 2560 x P. 560 x H. 530

Struttura monoscocca e cassetti in multistrati con foderina mdf per laccatura.
Laccatura glossy, decorazione pattern su cassetti. Lavorazione frontali cassetti con bordo a 45° per apertura.
Guide blu motion con chiusura ammortizzata.

DAISY tv stand

One-piece structure and drawers in plywood with MDF cover for lacquering.
Glossy lacquer, pattern decoration on drawers.
Drawer fronts with 45° edge for opening.
Blue Motion guides with soft closing.

Daisy

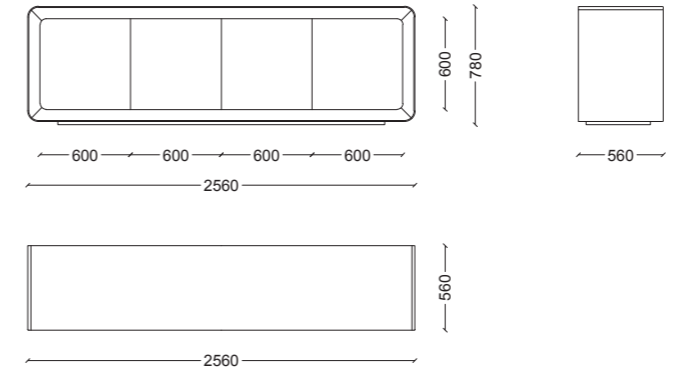

DAISY credenza Art. 00043

L. 2560 x P. 560 x H. 780

Struttura monoscocca ed ante in multistrati con foderina mdf per laccatura.
Laccatura glossy, decorazione pattern su ante.
Lavorazione ante con bordo a 45° per apertura.
Cerniere con cover e chiusura ammortizzata.

DAISY sideboard

One-piece structure and plywood doors with MDF lining for lacquering.
Glossy lacquering, decoration pattern on doors.
Door processing with 45° edge for opening.
Hinges with cover and soft closing.

Boomerang

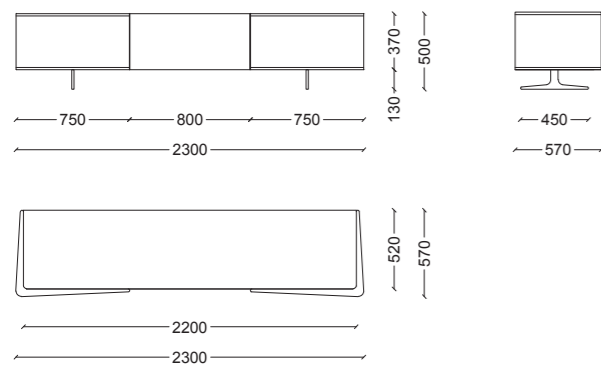

BOOMERANG porta tv Art. 00022

L. 2300 x P. 570 x H. 500

Struttura e cassetti in multistrati con foderina mdf per laccatura.
Laccatura glossy, decorazione pattern su cassetti/franchi laterali.
Apertura cassetto centrale con push-pull.
Guide blu motion con chiusura ammortizzata.
Piedi in acciaio verniciati a polvere.

BOOMERANG tv stand

Structure and drawers in plywood with MDF cover for lacquering.
Glossy lacquering, pattern decoration on sides of drawers/sides.
Central drawer Push-Pull opening.
Blue Motion guides with soft closing.
Feet in powder coated steel.

Daisy

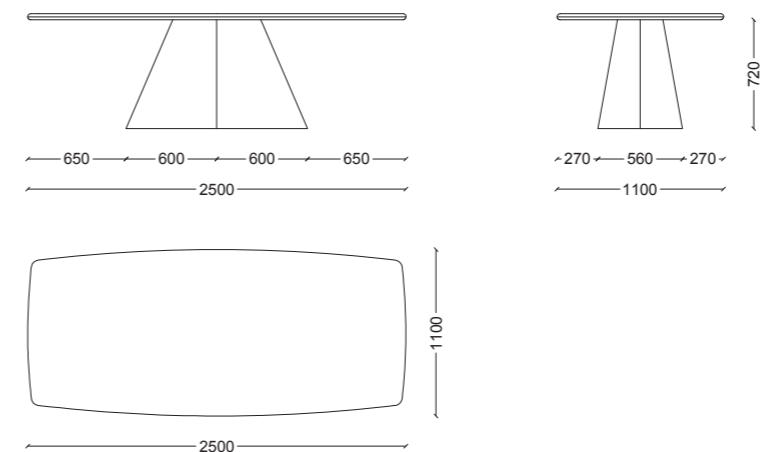

DAISY tavolo Art. 00017

L. 2500 x P. 1100 x H. 760

Basamento in acciaio strutturale con cover in poliuretano espanso.
Sottopiano spessore 40mm in multistrati e mdf con barre in acciaio stabilizzanti.
Top in cristallo extra chiaro spessore 15mm e retro laccato.
Basamento e sottopiano laccati glossy, decorazioni a pattern.

DAISY table

Steel base structural with polyurethane foam cover.
40 mm-thick undertop in plywood and MDF with stabilizing steel bars.
15mm-thick extra clear glass top and lacquered back.
Glossy lacquered base and undertop, patterned decorations.

Ant

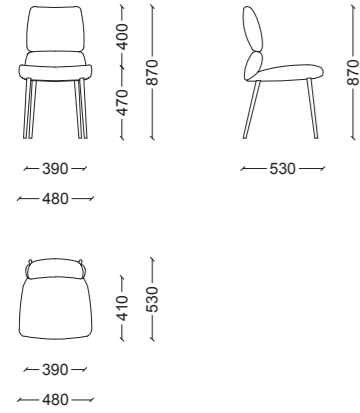

ANT sedia

Art. 00019

L. 480 x P. 530 x H. 870

Gambe coniche in acciaio verniciate glossy.
Struttura interna in acciaio sagomato,
imbottitura con gomme di varia densità su seduta e schienale.

ANT chair

Conical, glossy painted steel legs.
Internal structure in shaped steel,
padding with rubber of various densities on the seat and back.

Ninfa

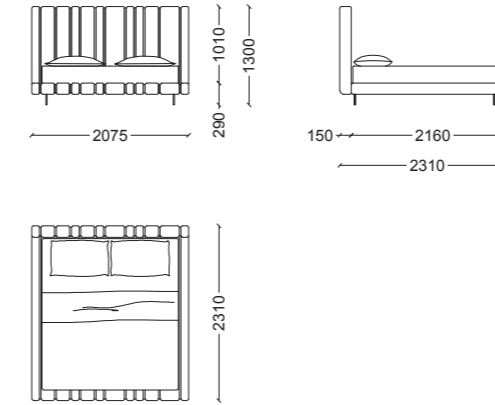

NINFA letto

Art. 00002

L. 2075 x P. 2310 x H. 1300

Struttura in multistrati, imbottita con gomme di varie densità.
Fissaggi con squadre in acciaio verniciate.
Predisposto per rete in appoggio.
Cordoncino decorativo realizzata a mano.
Piedi tecnici a scomparsa.
Elementi appendice con top in marmo
e piedi in acciaio verniciati a polvere.

NINFA bed

Multilayer structure in plywood, padded with multi-density rubber.
Painted steel square fixtures.
Prepared for the mattress base support.
Handmade decorative cord.
Technically retractable feet.
Appendix elements with marble top and powder-coated steel feet.

Boomerang

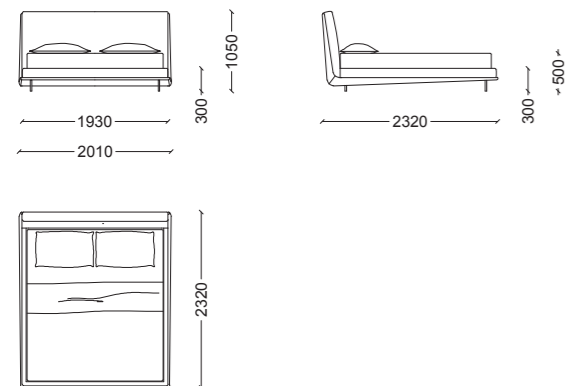

BOOMERANG letto

Art. 00023

L. 2010 x P. 2320 x H. 1050

Struttura in multistrati, imbottita con gomme di varie densità.
Fissaggi con squadre in acciaio verniciate;
predisposto per rete in appoggio.
Elementi boomerang in multistrati
e mdf laccati glossy con decorazioni pattern.
Piedi tecnici a scomparsa.

BOOMERANG bed

Multi-layer structure, padded with rubber of various densities.
Painted steel square fixtures form the mattress support base.
Boomerang elements in plywood and glossy lacquered MDF
with pattern decorations.
Technically retractable feet.

Ninfa

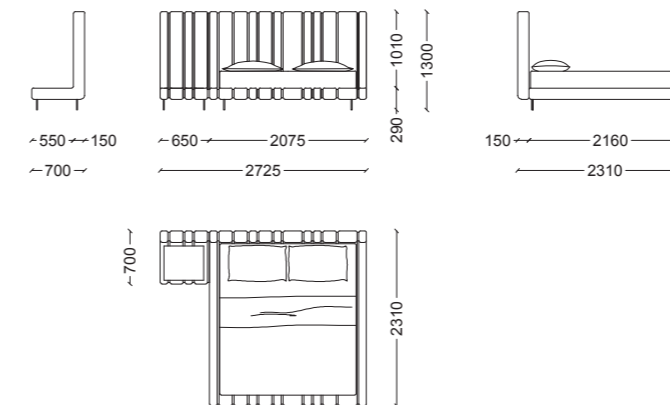

NINFA letto

Art. 00003

L. 2725 x P. 2310 x H. 1300

Struttura in multistrati, imbottita con gomme di varie densità.
Fissaggi con squadre in acciaio verniciate.
Predisposto per rete in appoggio.
Cordoncino decorativo realizzata a mano.
Piedi tecnici a scomparsa.
Elementi appendice con top in marmo
e piedi in acciaio verniciati a polvere.

NINFA bed

Multilayer structure in plywood, padded with multi-density rubber.
Painted steel square fixtures.
Prepared for the mattress base support.
Handmade decorative cord.
Technically retractable feet.
Appendix elements with marble top and powder-coated steel feet.

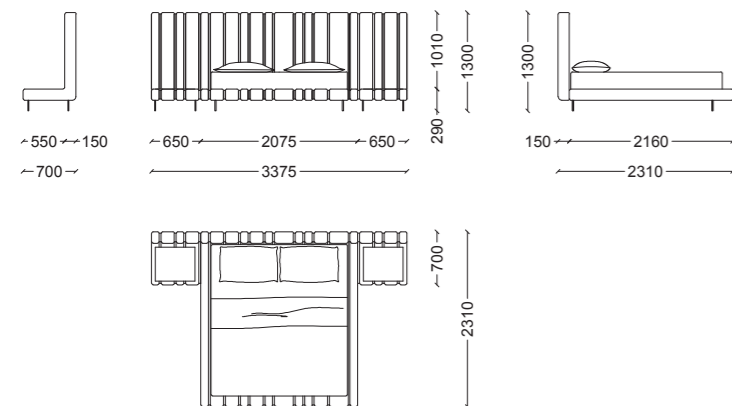

NINFA letto Art. 00004

L. 3375 x P. 2310 x H. 1300

Struttura in multistrati, imbottita con gomme di varie densità.
Fissaggi con squadre in acciaio verniciate.
Predisposto per rete in appoggio.
Cordoncino decorativo realizzata a mano.
Piedi tecnici a scomparsa.
Elementi appendice con top in marmo e piedi in acciaio verniciati a polvere.

NINFA bed

Multilayer structure in plywood, padded with multi-density rubber.
Painted steel square fixtures.
Prepared for the mattress base support.
Handmade decorative cord.
Technically retractable feet.
Appendix elements with marble top and powder-coated steel feet.

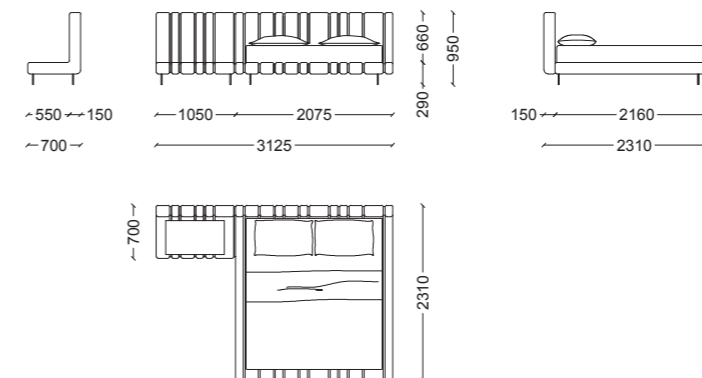

NINFA letto Art. 00013

L. 3125 x P. 2310 x H. 950

Struttura in multistrati, imbottita con gomme di varie densità.
Fissaggi con squadre in acciaio verniciate.
Predisposto per rete in appoggio.
Cordoncino decorativo realizzata a mano.
Piedi tecnici a scomparsa.
Elementi appendice con top in marmo e piedi in acciaio verniciati a polvere.

NINFA bed

Multilayer structure in plywood, padded with multi-density rubber.
Painted steel square fixtures.
Prepared for the mattress base support.
Handmade decorative cord.
Technically retractable feet.
Appendix elements with marble top and powder-coated steel feet.

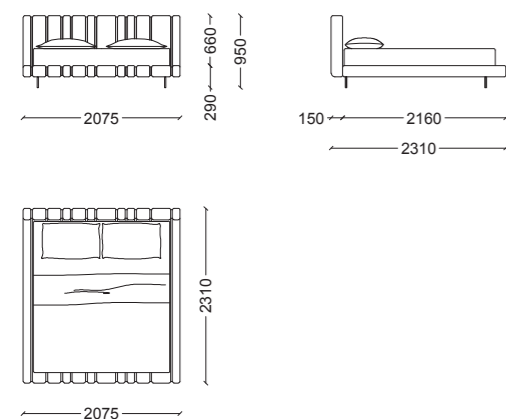

NINFA letto Art. 00029

L. 2075 x P. 2310 x H. 950

Struttura in multistrati, imbottita con gomme di varie densità.
Fissaggi con squadre in acciaio verniciate.
Predisposto per rete in appoggio.
Cordoncino decorativo realizzata a mano.
Piedi tecnici a scomparsa.
Elementi appendice con top in marmo e piedi in acciaio verniciati a polvere.

NINFA bed

Multilayer structure in plywood, padded with multi-density rubber.
Painted steel square fixtures.
Prepared for the mattress base support.
Handmade decorative cord.
Technically retractable feet.
Appendix elements with marble top and powder-coated steel feet.

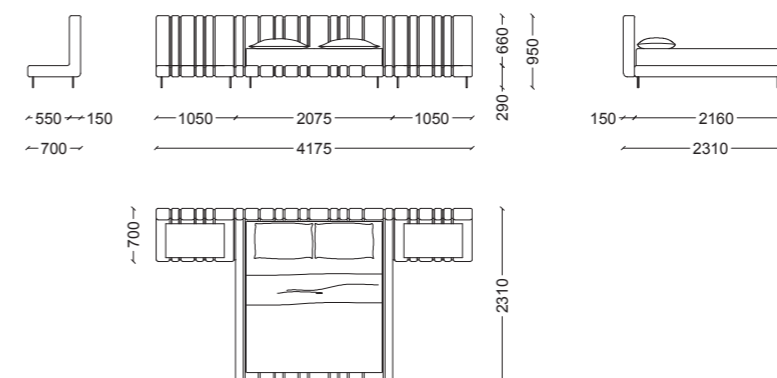

NINFA letto Art. 00014

L. 4175 x P. 2310 x H. 950

Struttura in multistrati, imbottita con gomme di varie densità.
Fissaggi con squadre in acciaio verniciate.
Predisposto per rete in appoggio.
Cordoncino decorativo realizzata a mano.
Piedi tecnici a scomparsa.
Elementi appendice con top in marmo e piedi in acciaio verniciati a polvere.

NINFA bed

Multilayer structure in plywood, padded with multi-density rubber.
Painted steel square fixtures.
Prepared for the mattress base support.
Handmade decorative cord.
Technically retractable feet.
Appendix elements with marble top and powder-coated steel feet.

Boomerang

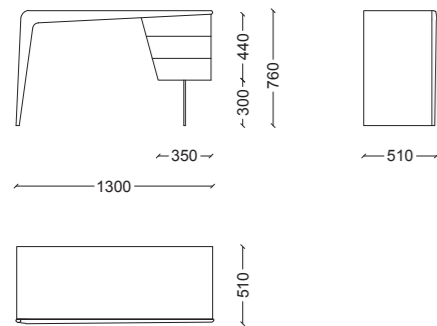

BOOMERANG VANITY toilette Art. 00026

L. 1300 x P. 510 x H. 760

Struttura e cassetti in multistrati con foderina mdf per laccatura.
Laccatura glossy, decorazione pattern su cassetti e boomerang.
Lavorazione frontale cassetti e scocca con bordo a 45°.
Maniglie in acciaio laccate.
Guide blu motion con chiusura ammortizzata.
Piede in acciaio laccato glossy.

BOOMERANG VANITY dressing table

Structure and drawers in plywood with MDF cover for lacquering.
Glossy lacquer, pattern decoration on drawers and boomerang.
Frontal processing of drawers and frame with 45° edge.
Lacquered steel handles.
Blue Motion guides with soft closing.
Feet in glossy lacquered steel.

Boomerang

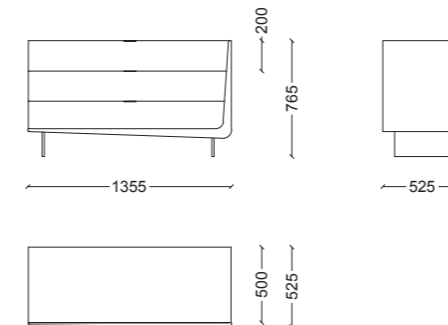

BOOMERANG comò Art. 00020

L. 1355 x P. 525 x H. 765

Struttura e cassetti in multistrati con foderina mdf per laccatura.
Laccatura glossy, decorazione pattern su boomerang.
Lavorazione frontali cassetti e scocca con bordo a 45°.
Maniglie in acciaio laccate.
Guide blu motion con chiusura ammortizzata.
Piede in acciaio laccato glossy.

BOOMERANG dresser

Structure and drawers in plywood with MDF cover for lacquering.
Glossy lacquer, pattern decoration on boomerang.
Front processing of drawers and shell with 45° edge.
Lacquered steel handles.
Blue Motion guides with soft closing.
Feet in glossy lacquered steel.

Boomerang

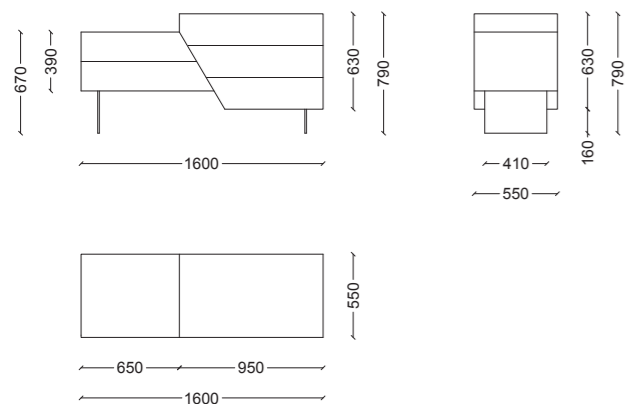

BOOMERANG comò Art. 00024

L. 1600 x P. 550 x H. 550

Struttura e cassetti in multistrati con foderina mdf per laccatura.
Laccatura glossy, decorazione pattern su cassetti.
Lavorazione frontale cassetti e scocca con bordo a 45°.
Maniglie in acciaio laccate.
Guide blu motion con chiusura ammortizzata.
Piedi in acciaio laccato glossy.

BOOMERANG dresser

Structure and drawers in plywood with MDF cover for lacquering.
Glossy lacquer, pattern decoration on drawers.
Frontal processing of drawers and frame with 45° edge.
Lacquered steel handles.
Blue Motion guides with soft closing.
Feet in glossy lacquered steel.

Boomerang

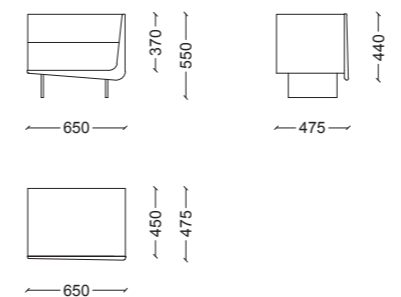

BOOMERANG comodino Art. 00025

L. 650 x P. 475 x H. 552

Struttura e cassetti in multistrati con foderina mdf per laccatura.
Laccatura glossy, decorazione pattern su boomerang.
Lavorazione frontali cassetti e scocca con bordo a 45°.
Maniglie in acciaio laccate.
Guide blu motion con chiusura ammortizzata.
Piede in acciaio laccato glossy.

BOOMERANG bedside table

Structure and drawers in plywood with MDF cover for lacquering.
Glossy lacquer, pattern decoration on boomerang.
Front processing of drawers and shell with 45° edge.
Lacquered steel handles.
Blue Motion guides with soft closing.
Feet in glossy lacquered steel.

Butterfly

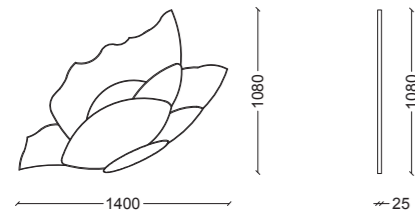

BUTTERFLY specchio per toilette Art. 00038

L. 1400 x P. 25 x H. 1080

Struttura in cristallo e plexiglass decorato e lavorato con tecnologie innovative.
Pannello posteriore strutturale in multistrati ed mdf laccato.

BUTTERFLY dressing table mirror

Glass and Plexiglas structure decorated and worked with innovative technologies.
Structure rear panel in plywood and lacquered MDF.

Latifoglia

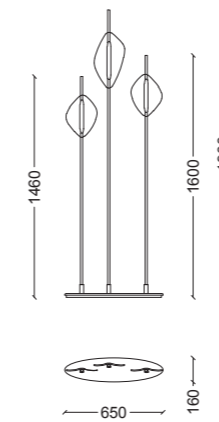

LATIFOGLIA piantana Art. 00031

L. 650 x P. 160 x H. 1900

Lampada con montatura in metallo, diffusore in vetro soffiato, cavo elettrico colore nero, pedaliera on/off, driver a spina classe I
220-240 V - 50/60 Hz
IP20
7W - 24v

LATIFOGLIA floor lamp

Lamp with metal fixtures, blown glass diffuser, black electric cable with on/off footswitch, Class I driver plug.
220-240 V - 50/60 Hz
IP20
7W - 24v

Butterfly

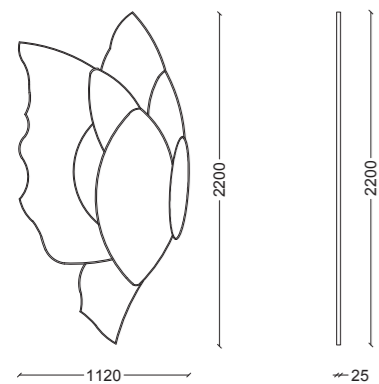

BUTTERFLY specchio xl Art. 00028

L. 1120 x P. 25 x H. 2200

Struttura in cristallo e plexiglass decorato e lavorato con tecnologie innovative.
Pannello posteriore strutturale in multistrati ed mdf laccato.

BUTTERFLY xl mirror

Glass and Plexiglas structure decorated and worked with innovative technologies.
Structure rear panel in plywood and lacquered MDF.

Latifoglia

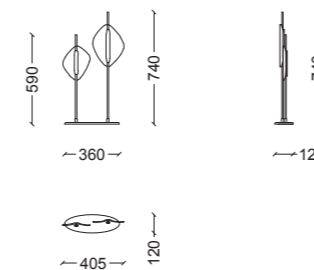

LATIFOGLIA lampada da tavolo Art. 00032

L. 405 x P. 120 x H. 740

Lampada con montatura in metallo, diffusore in vetro soffiato, cavo elettrico colore nero, interruttore on/off, driver a spina classe I
220-240 V - 50/60 Hz
IP20
5W - 24v

LATIFOGLIA table lamp

Lamp with metal fixtures, blown glass diffuser, black electric cable with on/off switch, Class I driver plug.
220-240 V - 50/60 Hz
IP20
7W - 24v

Latifoglia

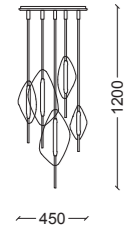

LATIFOGLIA lampadario Art. 00033

Ø 450 x H. 1200

Lampada con montatura in metallo, diffusore in vetro soffiato, cavo elettrico colore nero con morsetto, driver interno al rosone
classe I
220-240 V - 50/60 Hz
IP20
7W - 24v

LATIFOGLIA chandelier

Lamp with metal fixtures, blown glass diffuser, black electric cable with clamp, Class I driver inside the rosette.
220-240 V - 50/60 Hz
IP20
7W - 24v

Bluebell

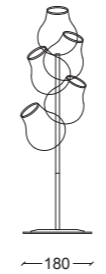

BLUEBELL lampada da tavolo Art. 00035

Ø 180 x H. 600

Lampada con montatura in metallo galvanizzato diffusore in vetro soffiato con anello metallico di finitura, cavo elettrico colore oro con pulsante on/off
classe I
220-240 V - 50/60 Hz
IP20
5x3,5W LED G9

BLUEBELL table lamp

Lamp with galvanized metal frame, blown glass diffuser with metallic finish ring. Golden electric cable with on/off button.
Class I.
220-240 V - 50/60 Hz
IP20
5x3,5W LED G9

Bluebell

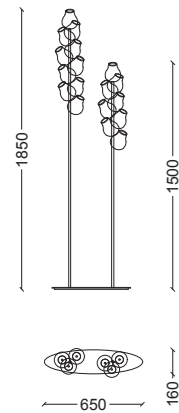

BLUEBELL piantana Art. 00034

L. 650 x P. 160 x H. 1850

Lampada con montatura in metallo galvanizzato champagne diffusore in vetro soffiato con anello metallico di finitura, cavo elettrico colore trasparente con pedaliera on/off per lampadine a led
classe I
220-240 V - 50/60 Hz
IP20
18x3,5W LED G9

BLUEBELL floor lamp

Lamp with champagne-coloured galvanized metal fixtures, blown glass diffuser with metallic finish ring. Transparent electric cable with on / off pedal for Class I LED bulbs
220-240 V - 50/60 Hz
IP20
18x3,5W LED G9

Bluebell

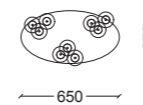
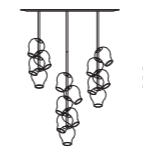

BLUEBELL lampadario Art. 00036

L. 650 x P. 350 x H. 900

Lampada con montatura in metallo galvanizzato diffusore in vetro soffiato con anello metallico di finitura, cavo elettrico con morsetto
classe I
220-240 V - 50/60 Hz
IP20
15x3,5W LED G9

BLUEBELL chandelier

Lamp with metal fixtures, blown glass diffuser with metallic finish ring. Electric cable with clamp.
Class I.
220-240 V - 50/60 Hz
IP20
15x3,5W LED G9

Dahlia

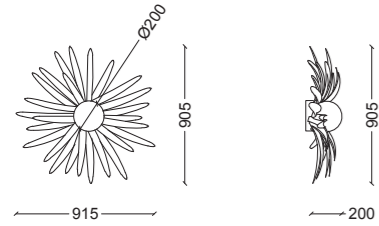

DAHLIA applique Art. 00037

L. 915 x P. 200 x H. 905

Lampada con montatura in metallo,
diffusore in vetro soffiato iridescente.
Cavo elettrico con morsetti.

Classe I
220-240 V - 50/60 Hz
IP20
1x5W E14

DAHLIA applique

Lamp with metal frame,
iridescent blown glass diffuser.
Electric cable with clamp.

Class I
220-240 V - 50/60 Hz
IP20
1x5W E14

Dandelion

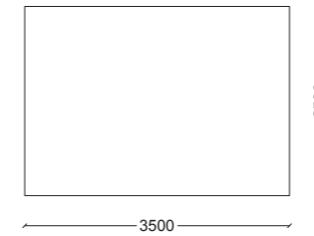

DANDELION tappeto Art. 00040

L. 3500 x P. 2500 x H. 13

Composizione in lana e seta di bamboo.
Annodato mano di alta qualità.
Altezza pelo 11-13 mm

DANDELION carpet

Composition in wool and bamboo silk.
High-quality hand knotting.
Pile height 11 - 13 mm.

Meteorite

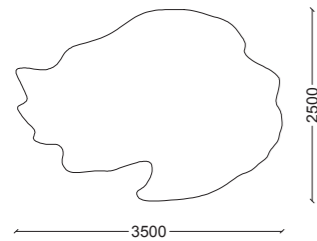

METEORITE tappeto Art. 00039

L. 3500 x P. 2500 x H. 13

Composizione in lana e seta di bamboo.
Annodato mano di alta qualità.
Altezza pelo 11-13 mm

METEORITE carpet

Composition in wool and bamboo silk.
High-quality hand knotting.
Pile height 11 - 13 mm.

Flaming Flame

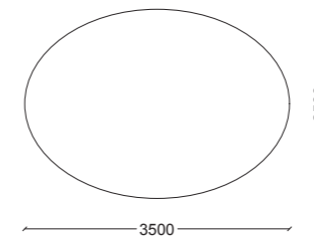

FLAMING FLAME tappeto Art. 00041

L. 3500 x P. 2500 x H. 13

Composizione in lana e seta di bamboo.
Annodato mano di alta qualità.
Altezza pelo 11-13 mm.

FLAMING FLAME carpet

Composition in wool and bamboo silk.
High-quality hand knotting.
Pile height 11 - 13 mm.

Pattern



DAISY



PANSY



MOSAICO



LACE

Laccati Lacquered finishes

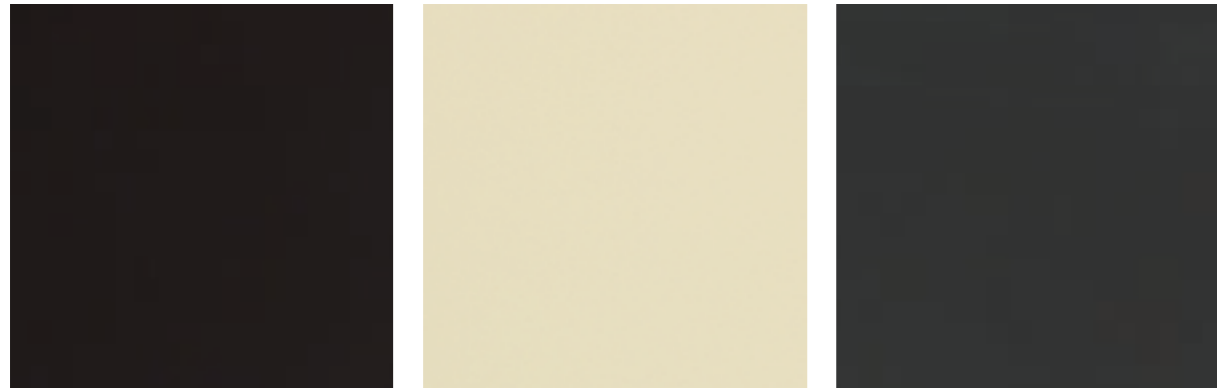

LONDRA MIAMI TOKYO



AVORIO VERDE ACQUA SMERALDO



BLU COBALTO GLICINE VINO

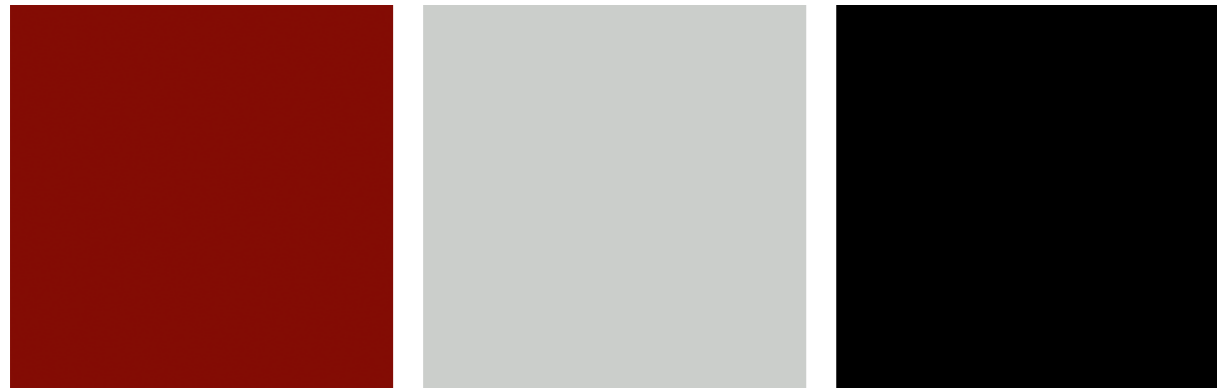

CHIANTI CEMENTO NERO

Vetri laccati Lacquered Glasses



LONDRA MIAMI TOKYO

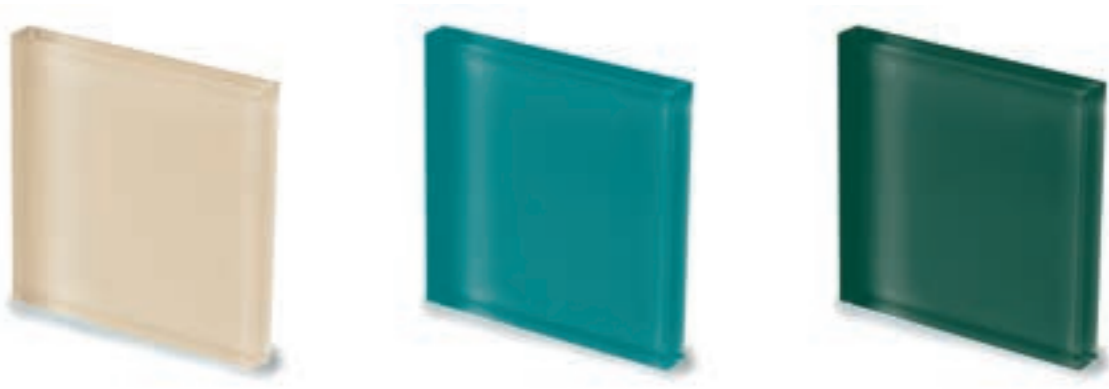

AVORIO VERDE ACQUA SMERALDO



BLU COBALTO GLICINE VINO



CHIANTI CEMENTO NERO

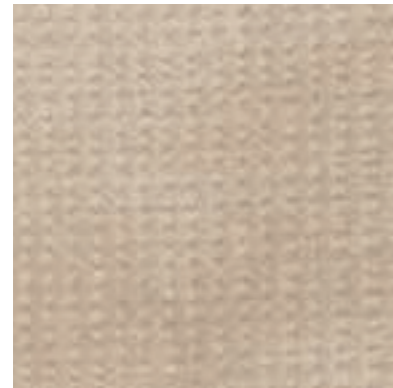

SAILOR 01 SABBIA



SAILOR 09 BLU

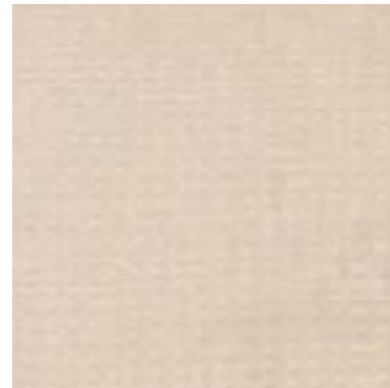

SAILOR 11 NATURALE

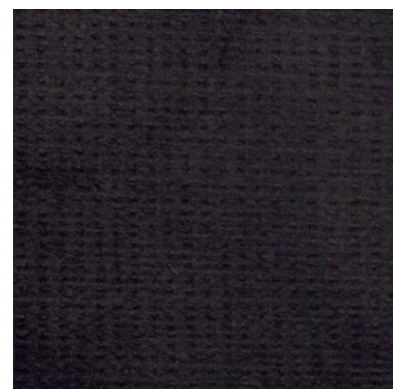

SAILOR 46 MOKA



SAILOR 121 GHIACCIO



SAILOR 165 MARMOTTA

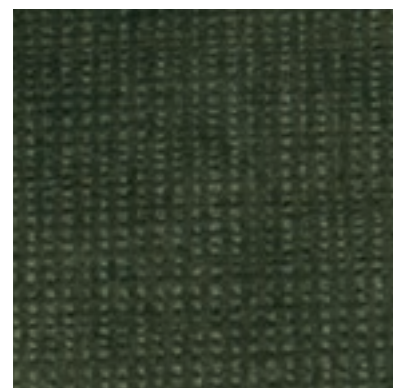

SAILOR 429 VERDE

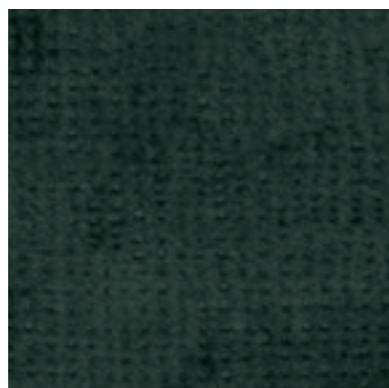

SAILOR 435 BOSCO



SAILOR 705 JEANS

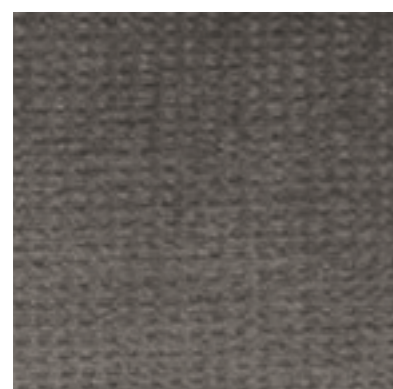

SAILOR 740 TORTORA

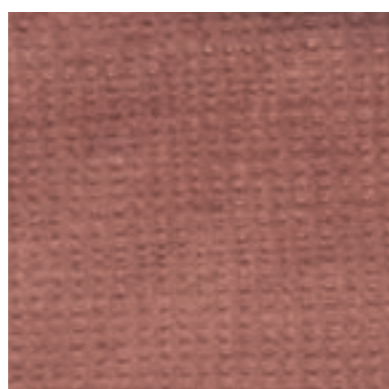

SAILOR 1670 CORALLO



SAILOR 1898 TERRACOTTA

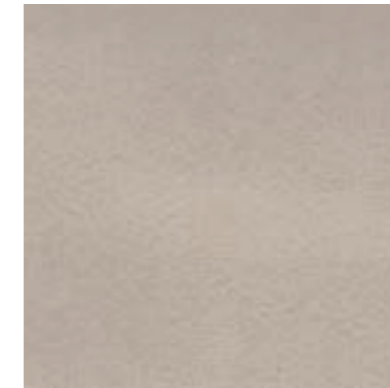

MOON LIGHT 104 CANAPA



MOON LIGHT 10 PORTOFINO

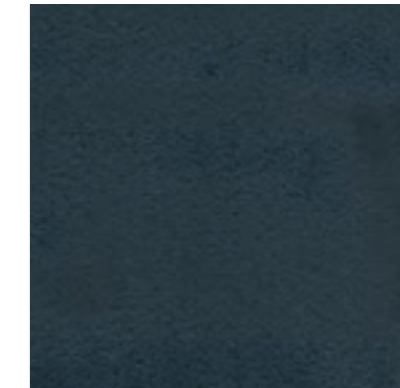

MOON LIGHT 14 AVIO

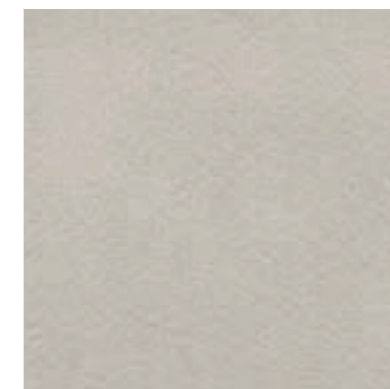

MOON LIGHT 20 TORTORA

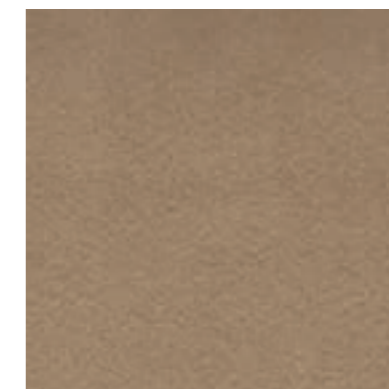

MOON LIGHT 04 CAMELLO



MOON LIGHT 03 DUNE

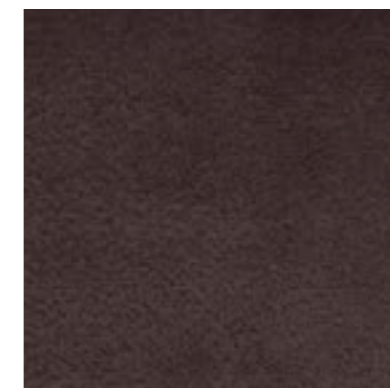

MOON LIGHT 11 VISONE

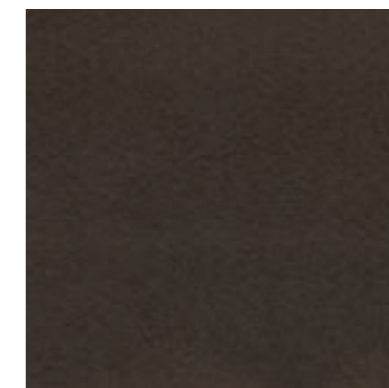

MOON LIGHT 100 CIOCCOLATO

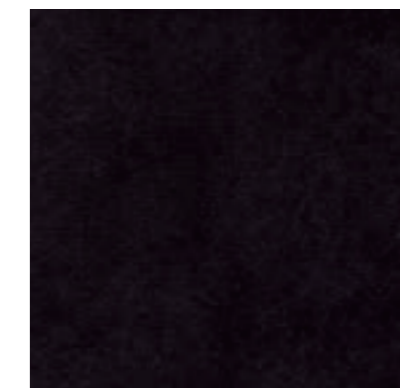

MOON LIGHT 18 NERO

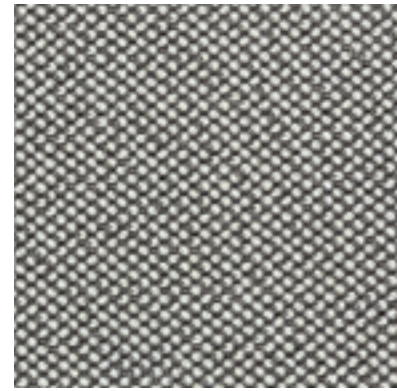

VENICE 01 SALEPEPE

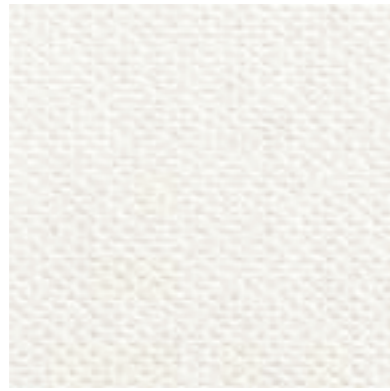

VENICE 02 WHITE



VENICE 05 SAND



VENICE 07 MOKA



VENICE 08 TORTORA

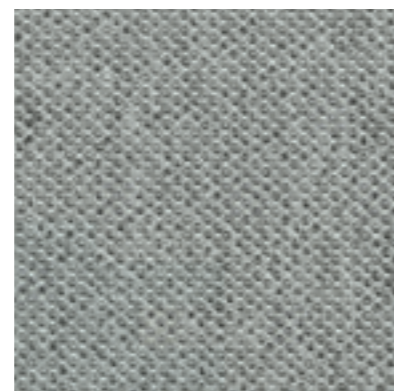

VENICE 09 SILVER

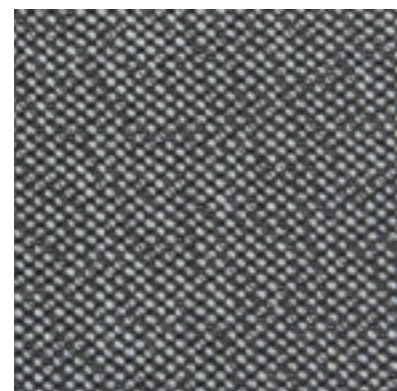

VENICE 11 GLACEE



VENICE 12 LONDRA



RITZ 02 SABBIA



RITZ 03 BEIGE



RITZ 04 GREIGE



RITZ 05 GREY

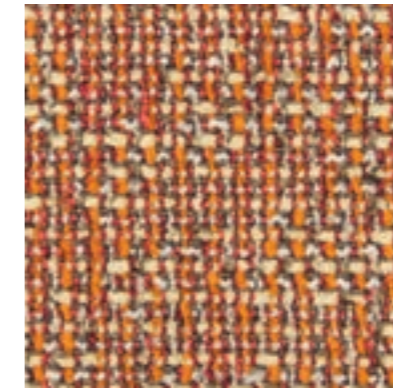

RITZ 08 RED



RITZ 09 BLU

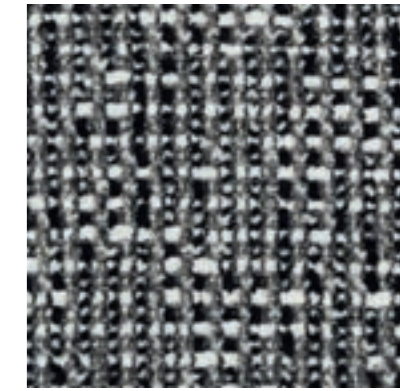

RITZ 12 SALEPEPE

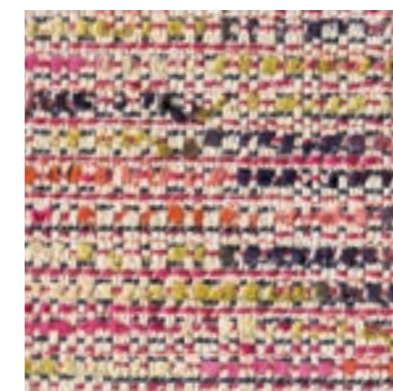

ISLAND 10

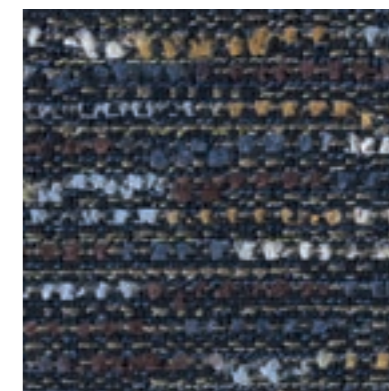

ISLAND 14

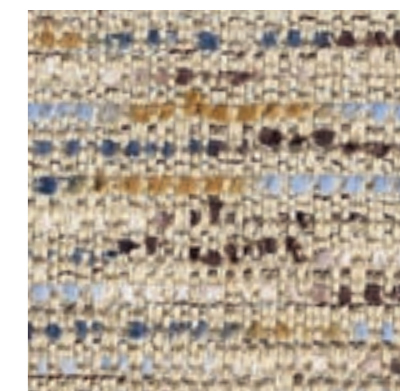

ISLAND 130

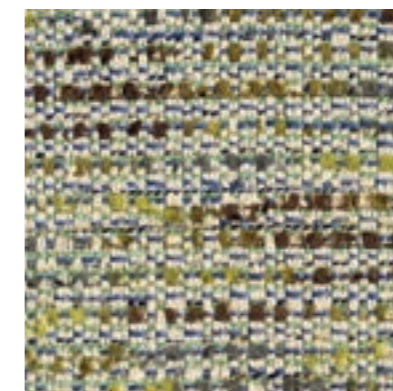

ISLAND 13

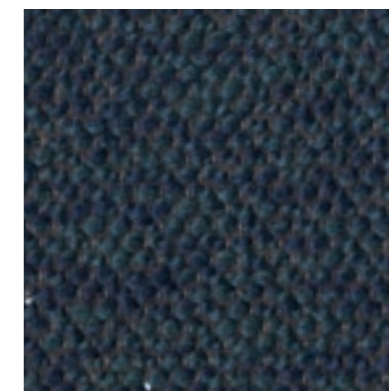

STELVIO 16

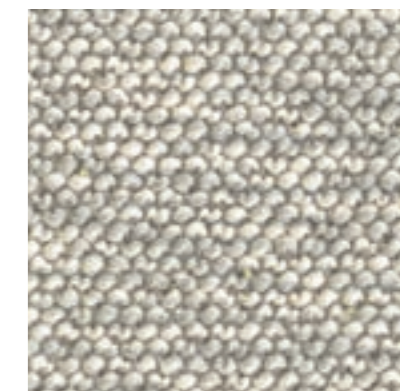

STELVIO 02

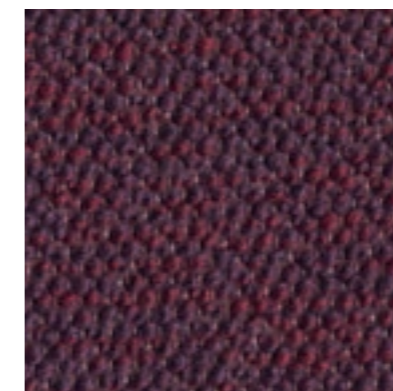

STELVIO 13

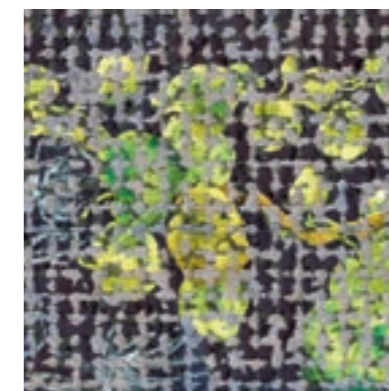

FLOREALE 04

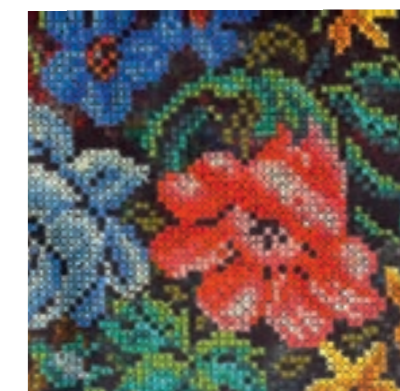

PUNTO CROCE 01



INFINITY 01 NATURALE



INFINITY 02 SACCO



INFINITY 14 PETROLIO



INFINITY 15 FELCE



INFINITY 16 SALVIA



INFINITY 18 MORO



ANGEL 10 NATURALE



ANGEL 13 SABBIA



ANGEL 14 ARMY



ANGEL 26 LORD

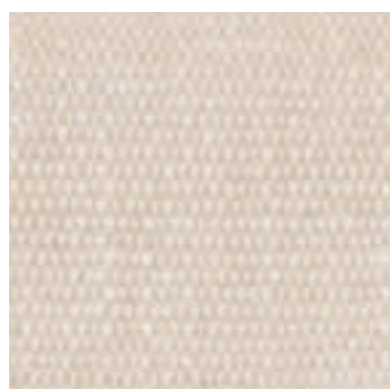

LULY 02 GESSO

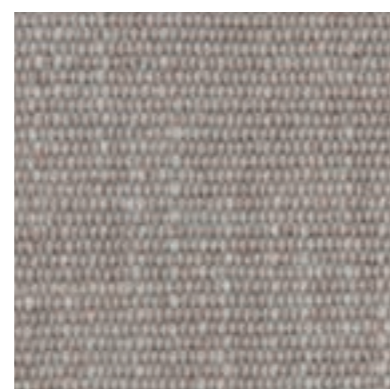

LULY 05 ARGENTO



LULY 06 CENERE

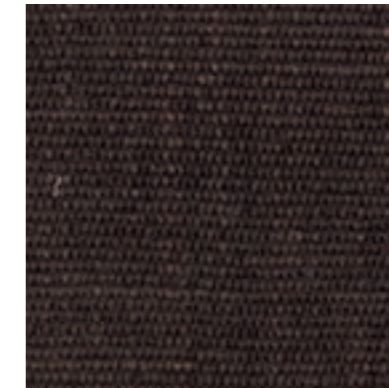

LULY 09 MOKA



LULY 10 VISONE

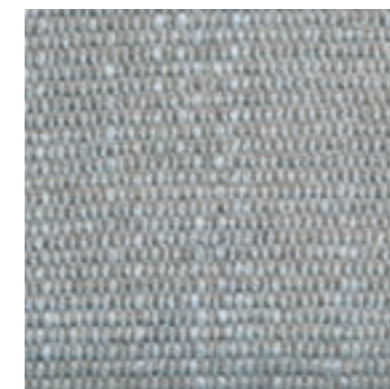

LULY 14 CIELO

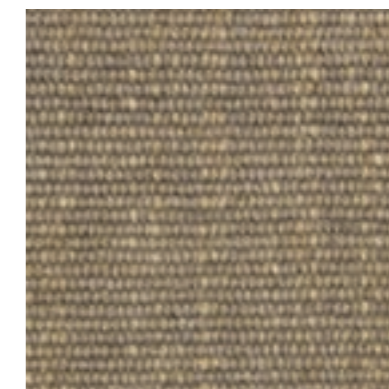

LULY 22 BEIGE

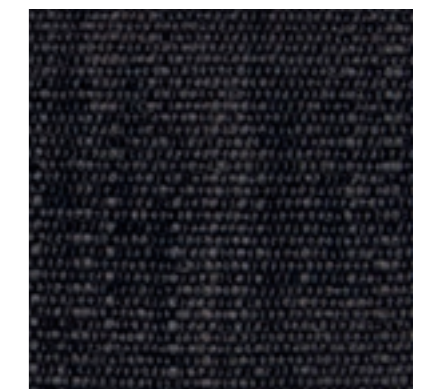

LULY 31 ANTRACITE



LULY 36 OCRA



LULY 38 BORDEAUX

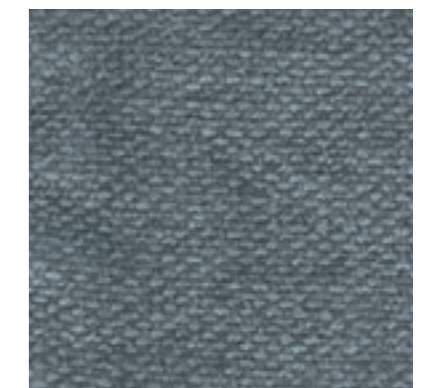

HAVANA 17 AVIO



HAVANA 205 ANTRACITE

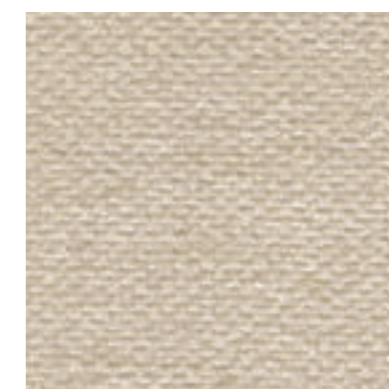

HAVANA 1 BEIGE



HAVANA 12 TORTORA

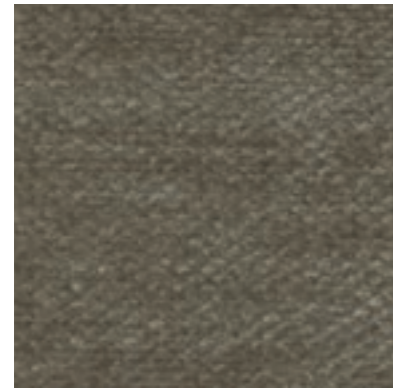

HAVANA 622 CRETA

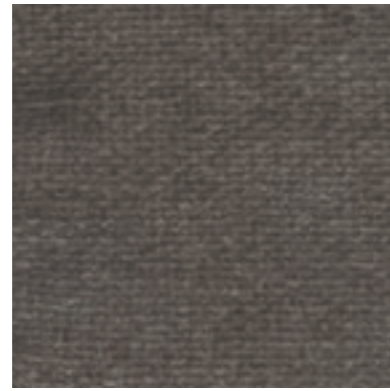

HAVANA 2 FANGO

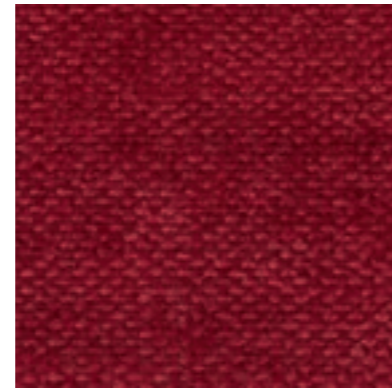

HAVANA 10 ROSSO



NICE 113 CONCHIGLIA



NICE 121 SABBIA



NICE 127 ARDESIA

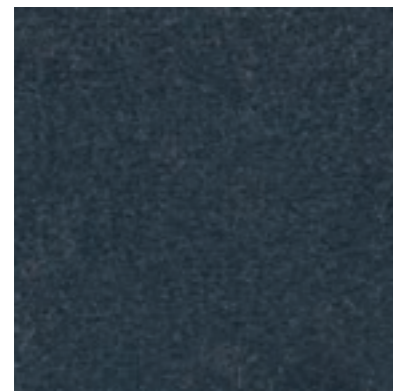

OLIVER 58 NAVY

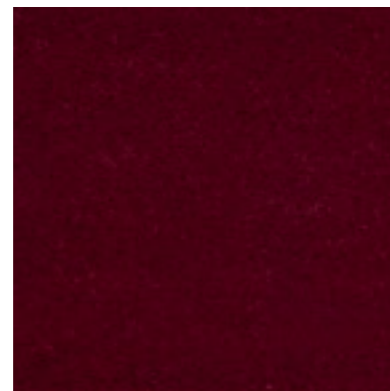

OLIVER 1405 VINO

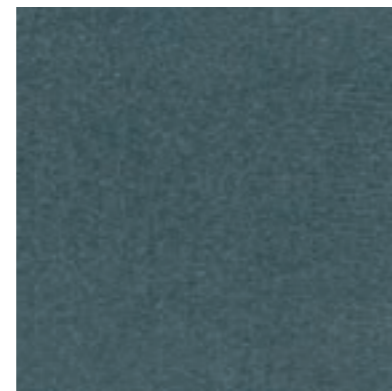

OLIVER 1406 AVIO



OLIVER 2003 GRIGIO

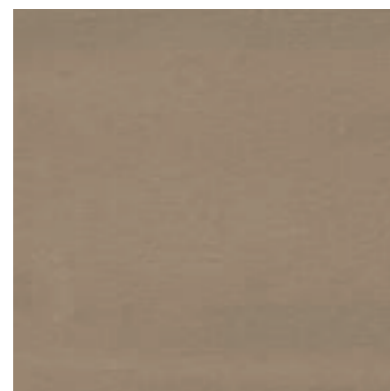

OLIVER 23 SABBIA

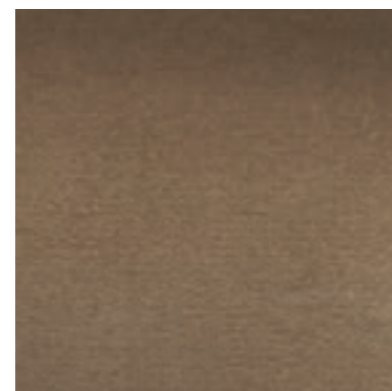

OLIVER 05 CASTAGNA



OLIVER 01 NEVE



OLIVER 09 VERDE



OLIVER 14 ZUCCA



OLIVER 1402 MUSCHIO

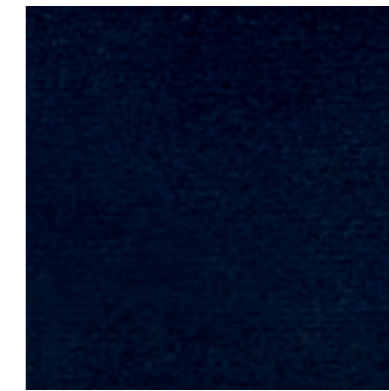

OLIVER 54 COBALTO



OLIVER 29 GHIACCIO



OLIVER 1404 GHISA

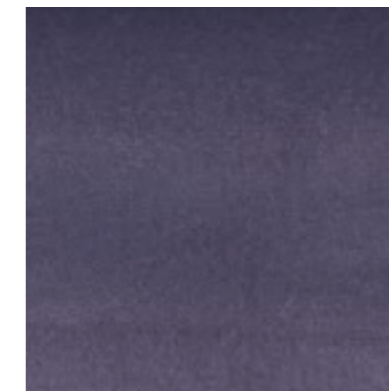

OLIVER 20



OLIVER 29

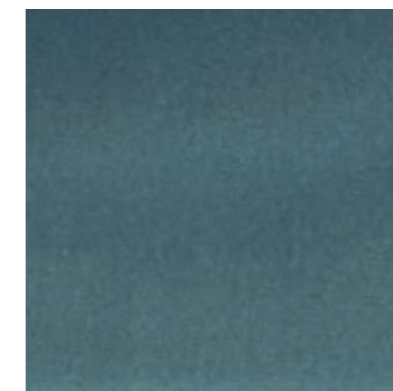

OLIVER 1406



OLIVER 03



VELVET 04 CRETA



VELVET 08 CIOCCOLATO

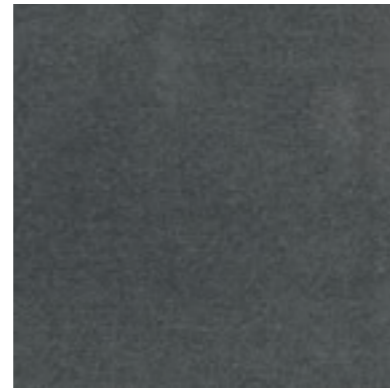

VELVET 11 GRIGIO

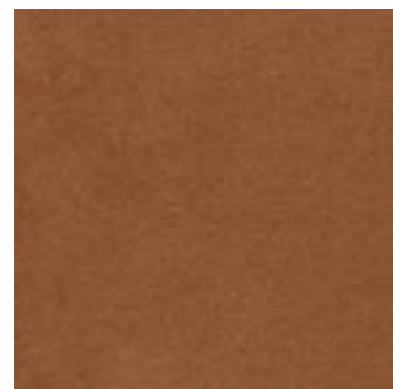

VELVET 28 MATTONE



VELVET 35 CIPRIA

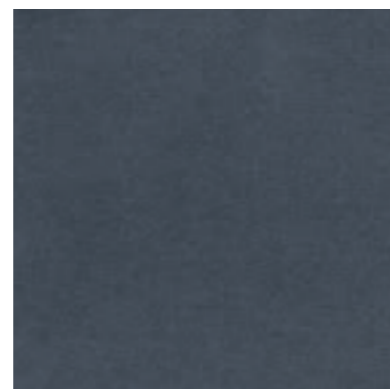

VELVET 111 CARTA DA ZUCCHERO



VELVET 19 CROMO

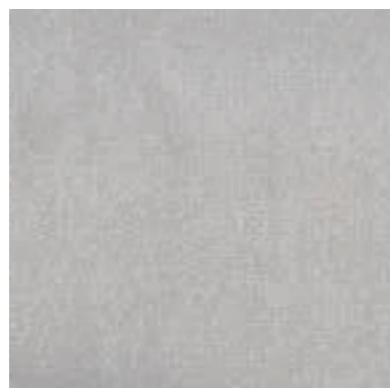

VELVET 18

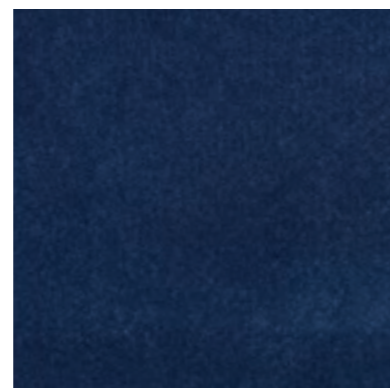

VELVET 1001 BLU NOTTE

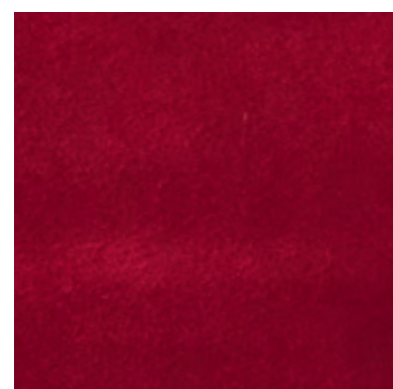

VELVET 1000 VINO

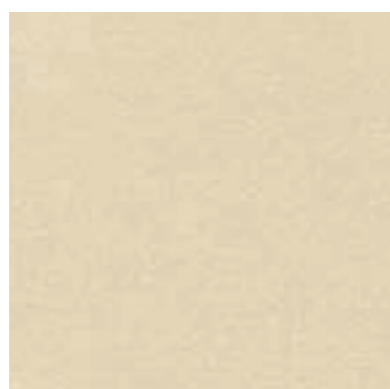

VELVET 02 PANNA

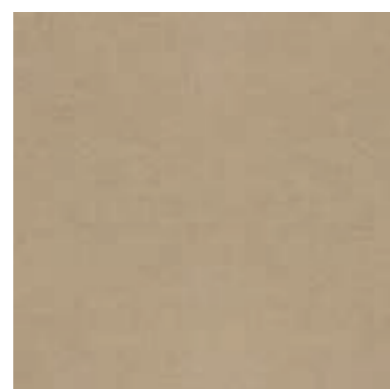

VELVET 1720 BEIGE

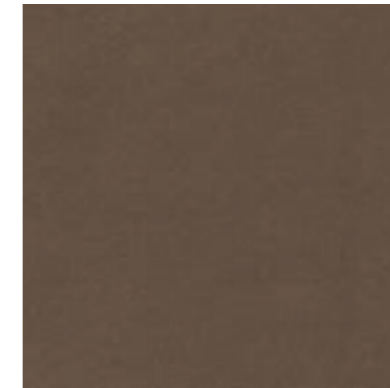

VELVET 1709 MILITARE

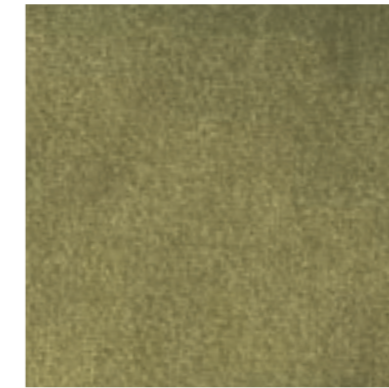

VELVET 05 VERDE



VELVET 07 GLICINE



VELVET 1803



SPLENDOR 01

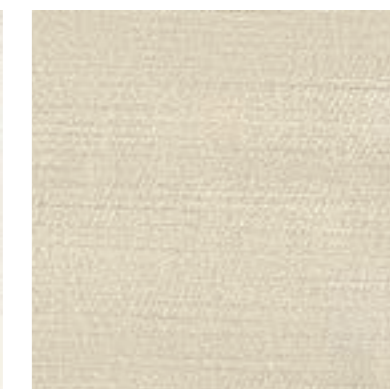

SPLENDOR 04 SABBIA



SPLENDOR 52 ROSSO



SPLENDOR 21



SPLENDOR 25 PETROLIO



SPLENDOR 29



SPLENDOR 43

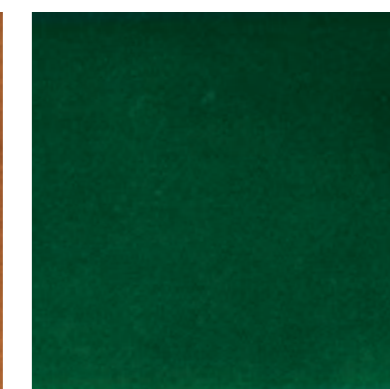

SPLENDOR 30

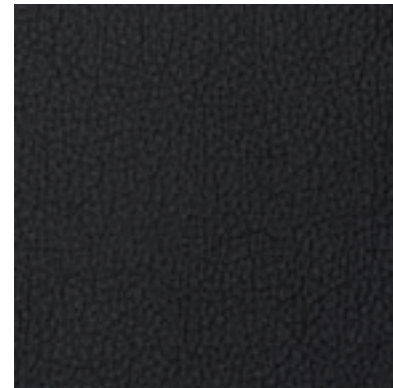

SYDNEY 610 BLACK



SYDNEY 615 COTTO

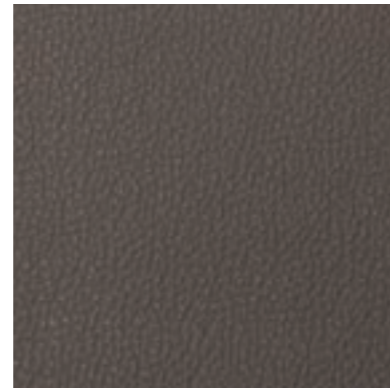

SYDNEY 631 GRAFITE

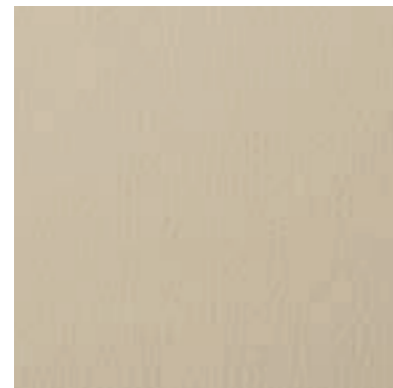

SYDNEY 651 SABBIA

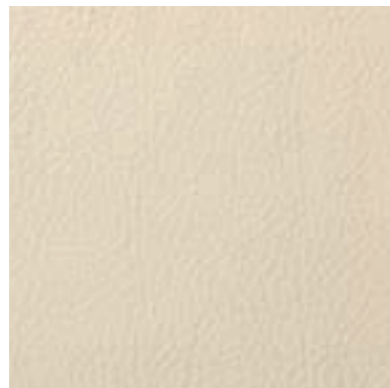

SYDNEY 682 GHIACCIO

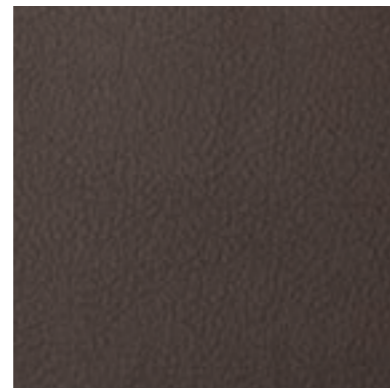

SYDNEY 692 TESTA DI MORO

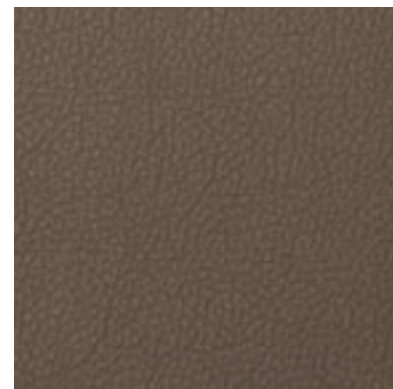

SYDNEY TORTORA



CLAYTON 1660 GRIGIO



CLAYTON 1639 LUMIERE

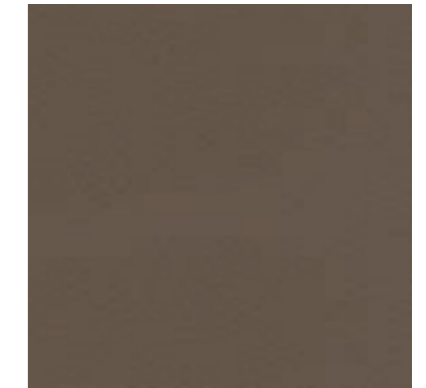

CLAYTON 1627 TORTORA

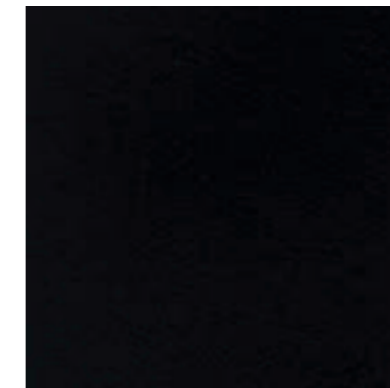

CLAYTON 1101 NERO

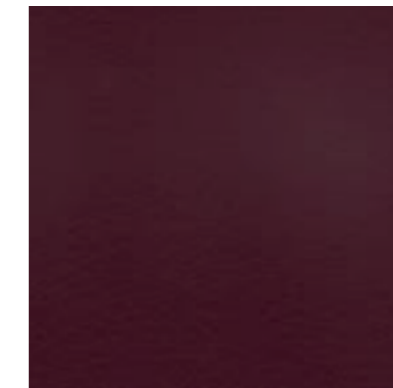

CLAYTON 1108 CHIANTI



CLAYTON 1147 DARK



CLAYTON 1179 GESSO

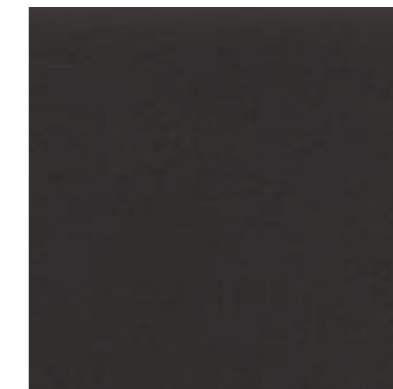

CLAYTON 1216 FANGO



CLAYTON 1226 BEIGE



LEONARDO 12 CRETA

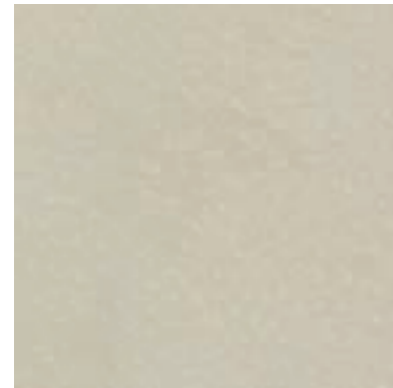

MIAMI 01 GESSO

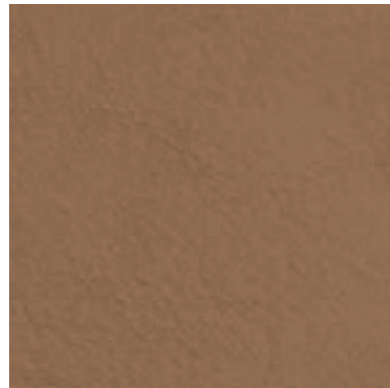

MIAMI 03 NATURALE

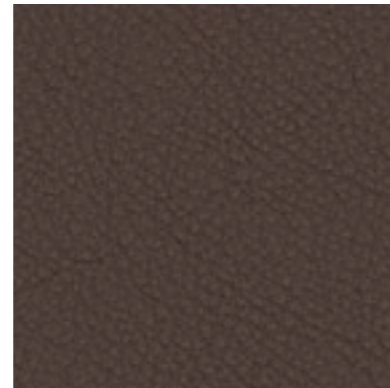

MIAMI 06 FANGO

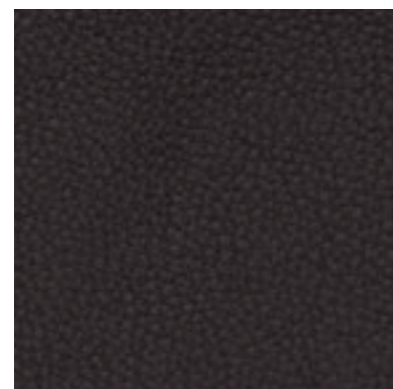

MIAMI 07 TESTA DI MORO

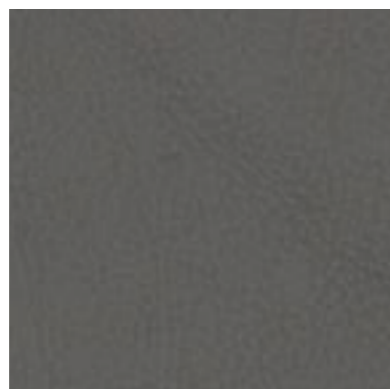

MIAMI 11 TORTORA

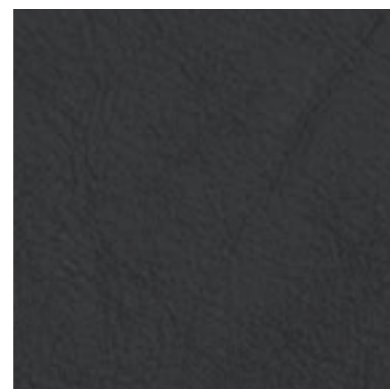

MIAMI 13 PIOMBO

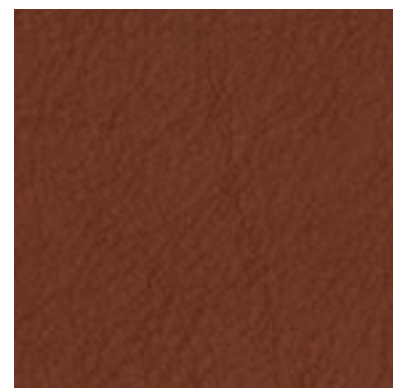

BALI 02 COTTO

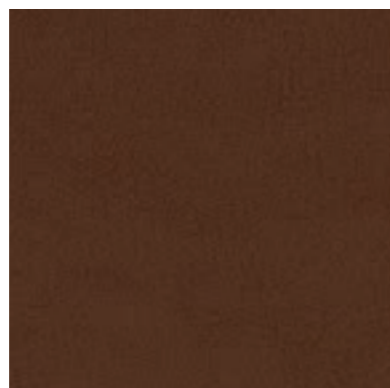

BALI 17 TABACCO



BALI 04 TESTA DI MORO



BALI 07 BLACK

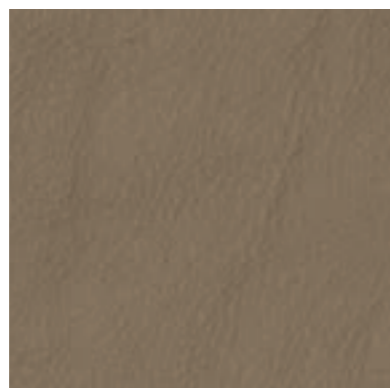

BALI 10 SABBIA



BALI 11 FUMO

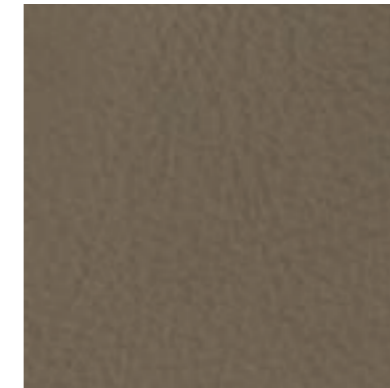

BALI 15 GREIGE

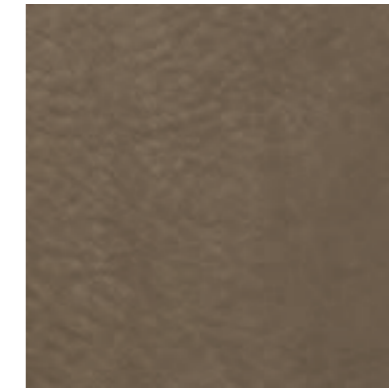

CAMOSCIO 8 FANGO

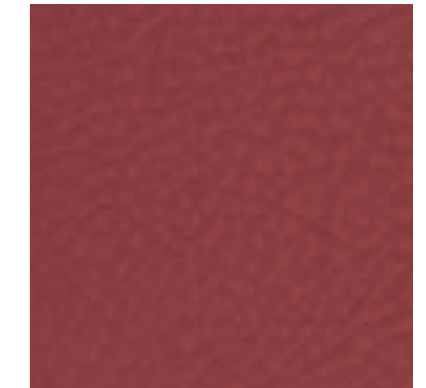

CAMOSCIO 16 PORTOFINO



CAMOSCIO 21 NAMIBIA



CAMOSCIO 23 DUNE



CAMOSCIO 26 GRIGIO

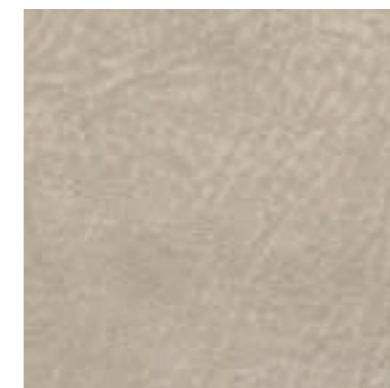

CAMOSCIO 31 PERLA



CAMOSCIO 27 TORTORA



CAMOSCIO 32 CORDA



CAMOSCIO 34 MOKA

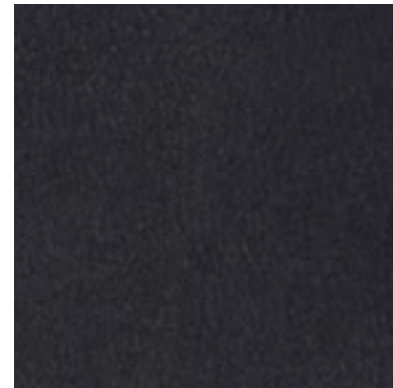

DELUXE 01 NERO

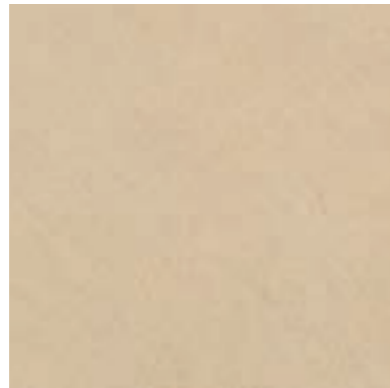

DELUXE 03 CREAM

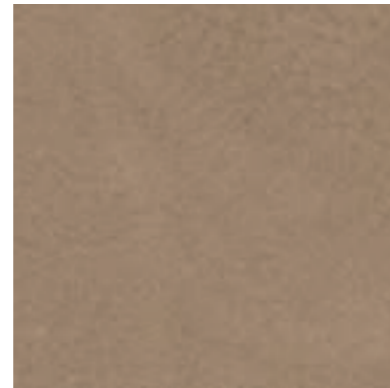

DELUXE 05 DUNE

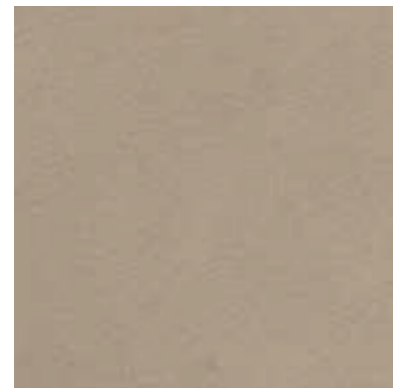

DELUXE 08 GREIGE

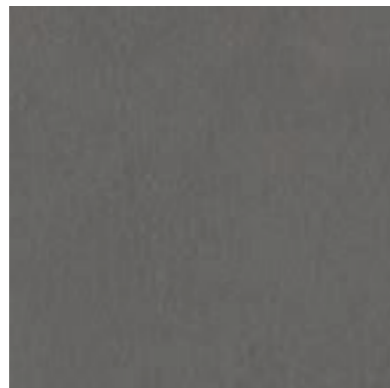

DELUXE 09 ARDESIA

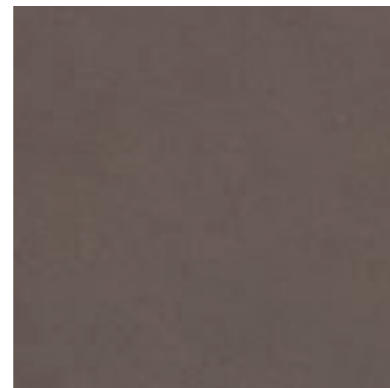

DELUXE 18 STONE

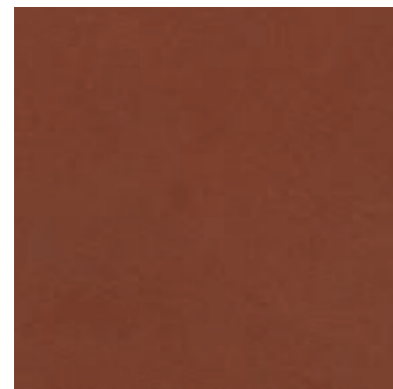

DELUXE 21 TERRA

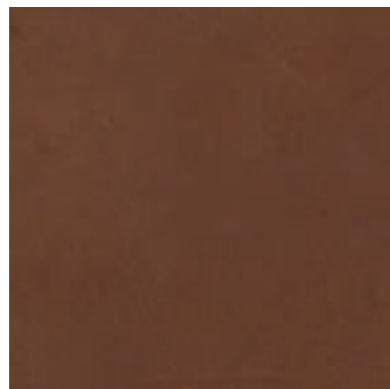

DELUXE 22 BROWN



DELUXE 23 ARGILLA

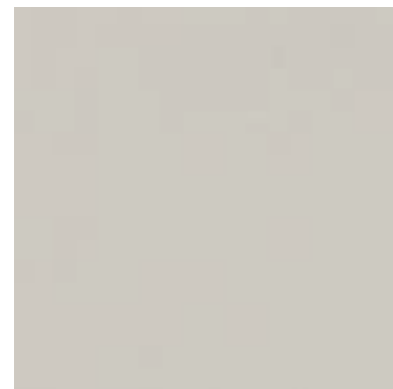

DELUXE 24 GESSO



DELUXE 25 CEMENTO

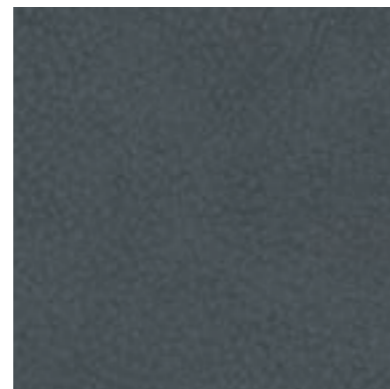

NABUK 2117 FERRO



NABUK 2116 TABACCO

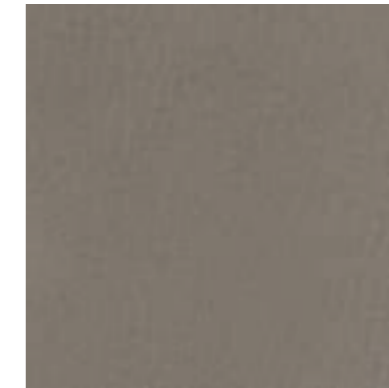

NABUK 2115 TORTORA

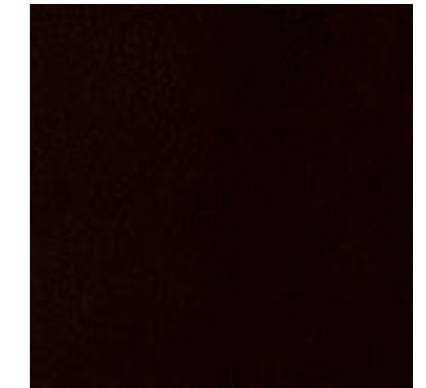

NABUK 2114 CIOCCOLATO

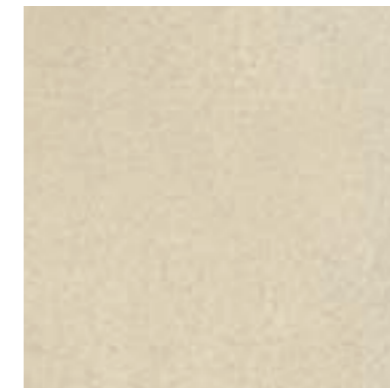

NABUK 2100 GESSO

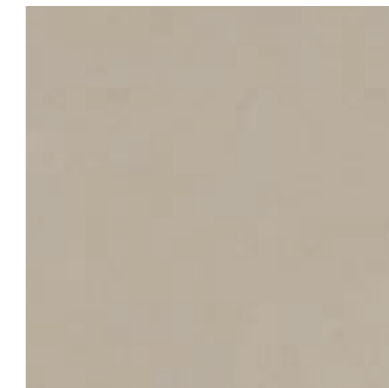

NABUK 2101 SABBIA

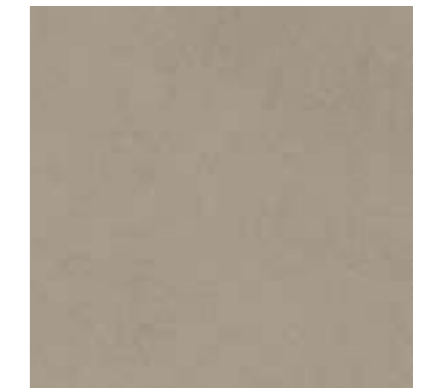

NABUK 2118 CANAPA

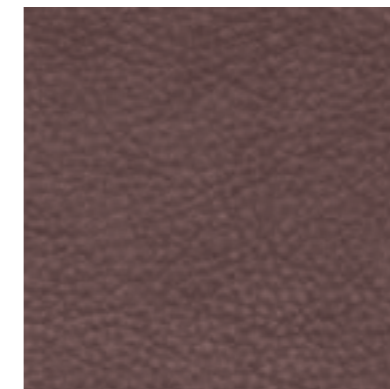

NABUK 10 ROSA ANTICO

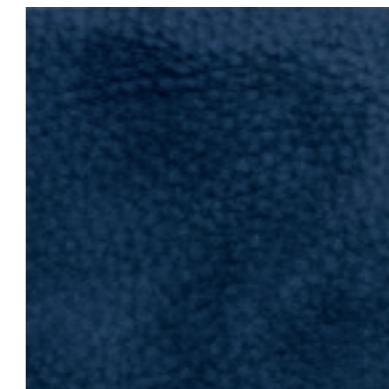

NABUK 18 BLU



NABUK 21 ROSSO

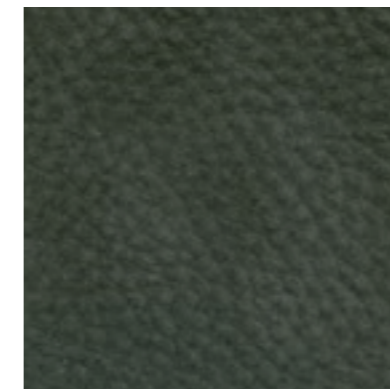

NABUK 24 MUSCHIO

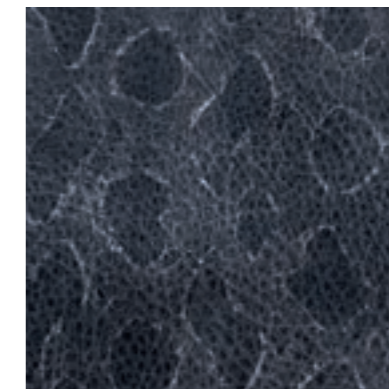

PEACOCK



DECOR

Cat. C



AGATHA BLACK

Cat. D



DOVER WHITE

Cat. C



ROSA ANTICO

Cat. D



PORT BLACK

Cat. D

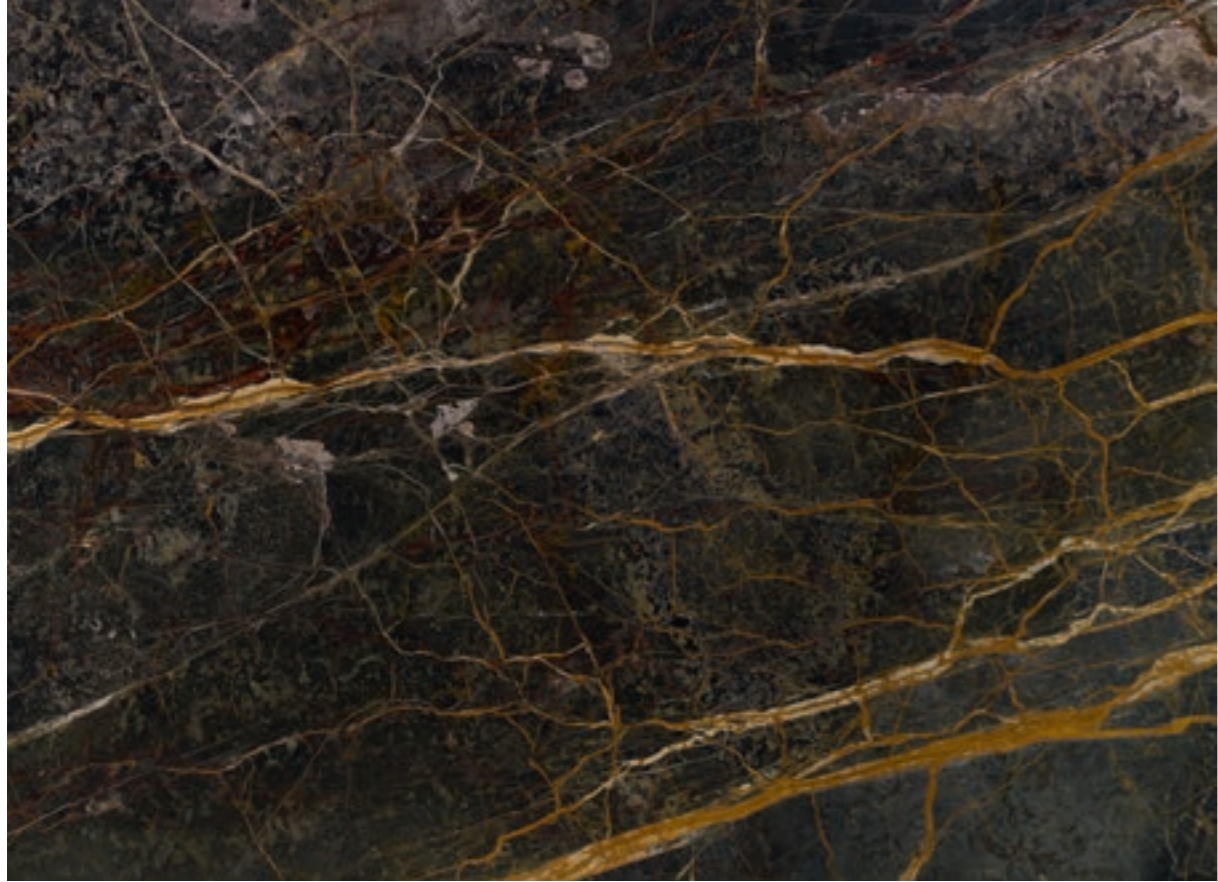

PORT SAINT LAURENT

Cat. E



SPIDERMAN

Cat. D

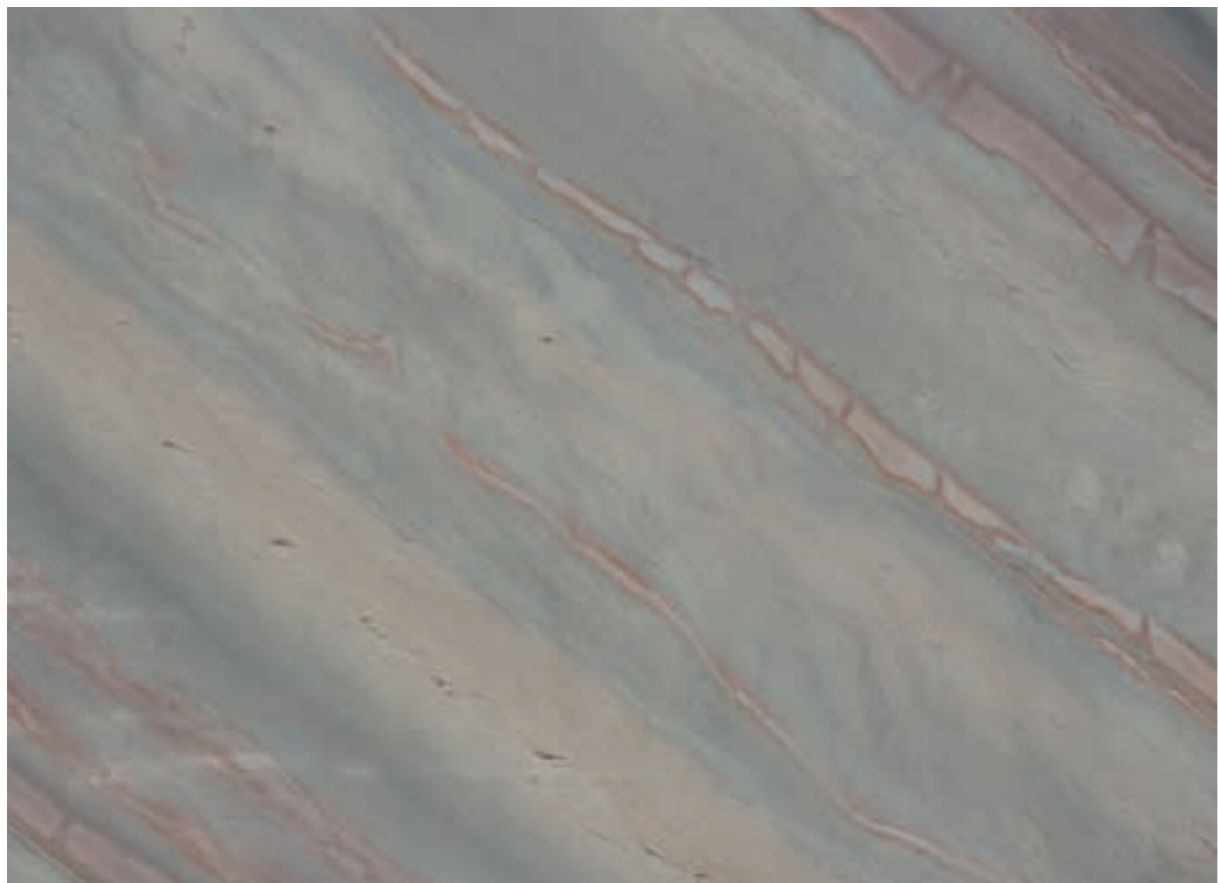

ELEGANT BROWN

Cat. F



CALACATTA ORO

ART DIRECTOR

Giuseppe Viganò
Studio Viganò

Photography

MyP-Studio.com

Prepress - Print

Tablab

Thanks to

M. Paolillo



Signorini-Coco&C. Srl
Via Lazio 41 56035
Perignano (Pisa) IT
T. +39 0587 616198
F. +39 0587 617540
info@signorinicoco.com
www.signorinicoco.com

Signorini & Coco si riserva di apportare, senza preavviso, modifiche nei materiali, nei rivestimenti, nelle finiture e nei disegni dei prodotti presentati in questo catalogo. I colori dei materiali e delle finiture hanno un valore indicativo in quanto soggetti alle tolleranze dei processi di stampa.

Signorini & Coco reserves the right to make modifications to the materials, coatings, finishes, and designs of the products presented in the catalogue without prior warning. The colours of materials and finishes are purely an indication as they may differ slightly due to the printing processes.

